

660

Agricultural Weight Indicators



Agri-Tronix Corporation
2001 North Morton Street
Franklin, IN 46131
317-738-4474

User & Service Manual

AWT35-100210

Issue AA

Avery Weigh-Tronix is a trademark of the Illinois Tool Works group of companies whose ultimate parent company is Illinois Tool Works Inc (“Illinois Tool Works”). Copyright © 2025 Illinois Tool Works. All rights reserved.

No part of this publication may be reproduced by making a facsimile copy, by the making of a copy in three dimensions of a two-dimensional work and the making of a copy in two dimensions of a three-dimensional work, stored in any medium by electronic means, or transmitted in any form or by any means, including electronic, mechanical, broadcasting, recording or otherwise without the prior written consent of the copyright owner, under license, or as permitted by law. This publication was correct at the time of going to print, however Avery Weigh-Tronix reserves the right to alter without notice the specification, design, price or conditions of supply of any product or service at any time.

Table of Contents

1	General Information and Warnings	5
1.1	About This Manual	5
1.2	Installation	6
2	Getting Started	9
2.1	The Avery Weigh-Tronix 660 Out of the Box	9
2.2	Installing and Powering Up the 660	9
2.3	Available Communication ports	12
2.4	Mounting a 660	13
2.5	Powering Up the 660	14
2.6	Updating the 660	15
3	Introduction	16
3.1	Front Panel	17
3.2	Annunciators	18
3.3	Display Messages	18
3.4	Display Annunciators	19
3.5	Available Communication ports	19
3.6	Entering Characters	20
3.7	Selecting a Unit of Measure	20
3.8	Menu Basics	21
4	Calibration	22
4.1	Calibration Through Remote Assist Application	22
4.2	In-App Calibration	23
4.3	Determine the Configuration Number	27
4.4	Ag Calibration from the Indicator	37
4.5	Indicator Calibration via the Admin Menu	38
5	Basic Operations for General Weighing	40
5.1	Zero	40
5.2	Gross Weighing	40
5.3	Tare	40
5.4	G/N Key Function	41
5.5	Printing	41
5.6	Load Unload	42
5.7	Auto Accumulation	43
5.8	AutoLoc	44
6	Remote Assist Mobile App Walkthrough	46
6.1	Remote Assist Mobile App Breakdown	46
6.2	Downloading the Remote Assist Application	46
6.3	Connecting a Scale	47
6.4	Mobile App Screen Navigation	48
6.5	Using the Active Scale Fields from the Remote Assist Mobile App	48
6.6	Text Prompt Messaging	49
6.7	Mobile App Settings	49
6.8	Configuration	50
6.9	Send/Receive Files	50
6.10	Select Device Keys	51
6.11	About Page	51
7	User Menu	52
7.1	Time	52
7.2	Date	53
7.3	Site ID	53
7.4	Seal	53
7.5	Diagnostics	54
7.6	Backlight	55
7.7	Ethernet	55

- 8 Supervisor Menu..... 56**
 - 8.1 General Supervisor Menu 56
 - 8.2 Load Unload..... 57
 - 8.3 Accumulation 58
 - 8.4 AutoLoc..... 59
 - 8.5 Input 60
 - 8.6 Print Format 61
 - 8.7 Reset All..... 62
 - 8.8 Mobile 63
 - 8.9 App Info..... 63
- 9 Administrator Menu..... 64**
 - 9.1 Setup Menu 64
 - 9.2 Diagnostics Menu..... 65
 - 9.3 About Menu 65
 - 9.5 Aduit Menu 66
- 10 Default Print Formats..... 67**
- 11 Technical Illustrations 69**
 - 11.1 660 Enclosure Assembly..... 69
 - 11.2 Parts Kit List 70
 - 11.3 System Block Diagram..... 75
 - 11.4 660 Jumper and Switch Settings 75
 - 11.5 660 Remote Inputs and Outputs, Opto-22 Module 76

Current Issue	Date Created	Details of Changes
AA	Aug 2025	New manual

1 General Information and Warnings

1.1 About This Manual

This manual is divided into sections by the section number and the large text at the top of a page. Subsections are labelled using the 1.1 and 1.1.1 convention. The page numbers appear at the bottom of the pages in the “Page x of y” format.

1.1.1 Text Conventions

Key names are shown in bold and in all capital letters: **HOLD**
MENU, **G/N**, **PRINT**, etc.

Navigational keys are displayed using directional arrows: ▲, ▼, ◀, and ▶

The indicator's **ON/OFF** key's “**ENTER**” function is displayed as ◀↵.

Displayed messages appear in bold italic type and reflect the case of the displayed message.

1.1.2 Special Messages

Special messages used in this manual are defined below. The heading words have specific meanings to alert users to additional information or the relative level of hazard.



ELECTRICAL WARNING!
THIS IS AN ELECTRICAL WARNING SYMBOL.
ELECTRICAL WARNINGS MEAN THAT FAILURE TO FOLLOW SPECIFIC PRACTICES OR PROCEDURES MAY RESULT IN ELECTROCUTION, ARC BURNS, EXPLOSIONS OR OTHER HAZARDS THAT MAY CAUSE INJURY OR DEATH.



WARNING!
This is a Warning symbol.
Warnings mean that failure to follow specific practices and procedures may have major consequences such as injury or death.



CAUTION!
This is a Caution symbol.
Cautions give information about procedures that, if not observed, could result in damage to equipment or corruption to and loss of data.



Note: This is a Note symbol. Notes give additional information about the product.

1.2 Installation



THE 660 DOES NOT CONTAIN USER-REPAIRABLE PARTS. REQUEST REPAIRS FROM QUALIFIED PERSONNEL.



WARNING!
To avoid damage, this appliance must be firmly anchored to the floor/wall according to the installation instructions.

ADVERTENCIA

Para evitar daños, este aparato tiene que estar firmemente anclado al suelo/pared según las instrucciones de instalación.



WARNING!
Internal batteries should not be exposed to excessive heat, such as sunlight, fire, or similar sources.

1.2.1 Wet Conditions

Under wet conditions, the power supply plug must be connected to the final branch circuit via an appropriate socket/receptacle designed for washdown use.

Installations within the USA should use a cover that meets NEMA 3R specifications as required by the National Electrical Code under section 410-57. This allows the unit to be plugged in with a rain tight cover fitted over the plug.

Installations in Europe must use a socket which provides a minimum of IP56 protection to the plug/cable assembly. Ensure that the degree of protection provided by the socket is suitable for the environment.

1.2.2 Routine Maintenance



Note: This equipment must be routinely checked for proper operation and calibration. Application and usage will determine the frequency of calibration required for safe operation.

Always turn off the indicator and isolate it from the power supply before starting any routine maintenance to avoid the risk of electric shock.

1.2.3 Safe Handling of Equipment with Batteries



CAUTION: *Danger of explosion if the battery is incorrectly replaced. Replace only with the same or equivalent type recommended by the manufacturer. Dispose of used batteries according to the manufacturer's instructions.*

1.2.4 Cleaning the Indicator



DO	DO NOT
Wipe down the outside with a clean cloth, moistened with water and a small amount of mild detergent.	Attempt to clean the inside of the indicator.
Spray the cloth when using a proprietary cleaning fluid.	Use harsh abrasives, solvents, scouring cleaners, or alkaline cleaning solutions.
	Spray any liquid directly on to the display windows.

1.2.5 Training

Users must not attempt to operate or complete any procedure on this indicator unless they have received the appropriate training or read the instructions.

To avoid the risk of RSI (Repetitive Strain Injury), place the indicator on a surface which is ergonomically satisfactory to the user. Take frequent breaks during prolonged usage.

1.2.6 Sharp Objects

Do not use sharp objects such as screwdrivers, knives/boxcutters, or pens to operate the keys.

1.2.7 Operation of Equipment

The operation of this equipment is subject to the following two conditions:

1. This equipment or device may not cause harmful interference.
2. This equipment or device must accept any interference. Including the one that may cause unwanted operation.

La operación de este equipo está sujeta a las siguientes dos condiciones:

1. Es posible que este equipo o dispositivo no cause interferencia perjudicial.
2. Este equipo o dispositivo debe aceptar cualquier interferencia. Incluyendo la que pueda causar su operación no deseada.

1.2.8 FCC and EMC Declarations of Compliance

United States

This equipment has been tested and found to comply with the limits for a Class A digital device, pursuant to Part 15 of the FCC Rules. These limits are designed to provide reasonable protection against harmful interference when the equipment is operated in a commercial environment. This equipment generates, uses, and can radiate radio frequency energy and, if not installed and used in accordance with the instruction manual, may cause harmful interference to radio communications. Operation of this equipment in a residential area is likely to cause harmful interference in which case the user will be required to correct the interference at his own expense.

Canada

This digital apparatus does not exceed the Class A limits for radio noise emissions from digital apparatus set out in the Radio Interference Regulations of the Canadian Department of Communications.

Le présent appareil numérique n'émet pas de bruits radioélectriques dépassant les limites applicables aux appareils numériques de la Classe A prescrites dans le Règlement sur le brouillage radioélectrique édicté par le ministère des Communications du Canada.

European Countries

WARNING: This is a Class A product. In a domestic environment, this product may cause radio interference in which the user may be required to take adequate measure

2 Getting Started

2.1 The Avery Weigh-Tronix 660 Out of the Box

Included with your new indicator

- The Avery Weigh-Tronix 660 Agricultural Indicator
- 2 Jumpers for the PCB
- 2 Extra Bluetooth Connection QR Code Stickers
- 1 Manual QR Code Sticker



2.2 Installing and Powering Up the 660

This section is a quick start guide for the Avery Weigh-Tronix 660 Agricultural Weight Indicator. Follow the below steps to get a 660 up and running.

1. All plugs and ports have guiding keys molded into the plastic. If the plug is not seating correctly, rotate it clockwise while applying slight pressure to the port until the keys line up and slide together. All wide guiding keys should be towards front side of indicator.
2. Connect the power cable to the necessary power supply:
 - There is an option for an external 100-240VAC 50/60Hz power supply. To power up the indicator, plug in the AC power cord into a properly grounded outlet.
 - Rated System Input: 12-24VDC @ 1.0A max draw from fully loaded indicator excluding peripherals (8 x 350 load cell), 500mA out the 5V COM port terminal block, 500mA load on USB Host.



Note: The system may draw more than the rated power when using the DB9 COM port to power external equipment from 660's input supply, like a printer or XLR remote display. In such as case, the power requirements for the external equipment should be added to the 660's power requirement when sizing fuses or power supplies.

3. When the Always On function is disabled the **ON/OFF** key must be pressed to power up the indicator.

Power Cable Connection

Input Supply Required: 12-24VDC @ 1A max draw from fully loaded indicator excluding peripherals;
Optional external AC/DC supply available.

There are two power cord options depending on the part-number purchased:

2-Pin "AWT" Power Connector

Pin A = 12-24VDC Input

Pin B = Ground (GND)

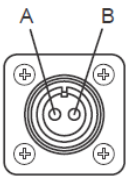

Outside View
(Female)



4-Pin "AMP" Power Connector

Pin 1 = 12-24VDC Input

Pin 2 = Ground (GND)

Pin 3 = No Connection

Pin 4 = No Connection

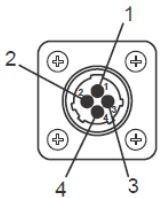

Outside View
(Male)



Scale Connection(s)

Connector(s) for interfacing to an external load cell or junction box.

5-Pin "AWT" Scale Connector

Pin A = (-) Signal

Pin B = (+) Excitation

Pin C = (+) Signal

Pin D = (-) Excitation

Pin E = Shield/Drain

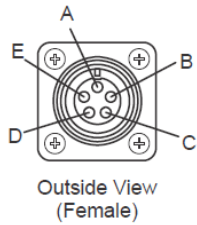

4-Pin "AMP" Scale Connector

Pin 1 = (+) Excitation

Pin 2 = (-) Signal

Pin 3 = (+) Signal

Pin 4 = (-) Excitation

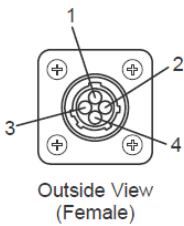

2.3 Available Communication ports

To allow the 660 to connect to a wide range of peripheral devices like printers, remote displays, phones, and tablets the indicator comes standard with the following connection ports.

- 1 x DB9 Port
- 1 x USB host
- 1 x Bluetooth

DB9 Connector:

- 5V @ 500 mA Output Supply
- +VBAT Supply Pass-Through
- Two RS232 channels (COM 1 default is set to Remote and COM 2 default is set to Print)
- Two Configurable Input/Output Channels
- DB9 High-Density Port

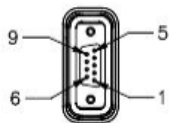

- Pin 1 = IO1 (In/Out)
- Pin 2 = COM1 RXD (In)
- Pin 3 = COM1 TXD (Out)
- Pin 4 = +VBAT @ 5A Max (Out)
- Pin 5 = Ground
- Pin 6 = IO2 (In/Out)
- Pin 7 = COM2 TXD (Out)
- Pin 8 = COM2 RXD (In)
- Pin 9 = +5V @ 500mA Max (Out)

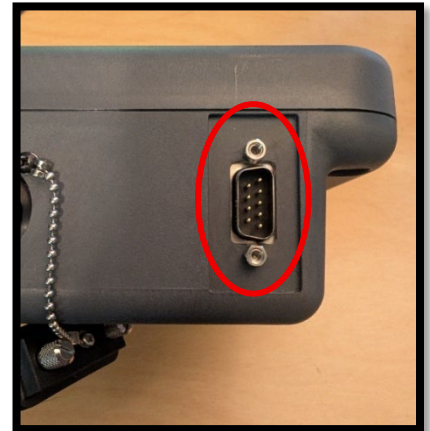

660 SERIAL-PORT & IO SPLITTER OPTION:

A serial-splitter junction box option is available for when more than one external item needs to make use of the DB9 port. This junction box connects to the DB9 port on the 660 and exposes each of the two RS232 channels on its own connector, plus a third connector for interfacing to the two IO channels. The junction-box utilizes the 8- and 9-Pin plastic AMP connectors used in legacy agricultural indicators, which can also aid in backward compatibility.

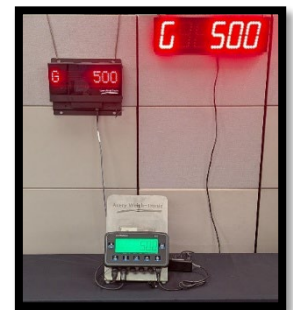

COM1 CONNECTOR:

- Pin 1 = No Connection
- Pin 2 = TXD1
- Pin 3 = No Connection
- Pin 4 = RXD1
- Pin 5 = Ground
- Pin 6 = Ground
- Pin 7 = +5VDC
- Pin 8 = +VBAT

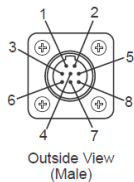

IO CONNECTOR:

- Pin 1 = +VBAT
- Pin 2 = +5VDC
- Pin 3 = Ground
- Pin 4 = No Connection

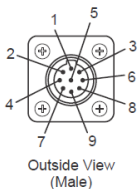

- Pin 5 = No Connection
- Pin 6 = Ground
- Pin 7 = IO1
- Pin 8 = IO2
- Pin 9 = No Connection

COM2 CONNECTOR:

- Pin 1 = No Connection
- Pin 2 = TXD2
- Pin 3 = No Connection
- Pin 4 = RXD2
- Pin 5 = Ground
- Pin 6 = Ground
- Pin 7 = +5VDC
- Pin 8 = +VBAT

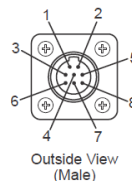

Note: When connecting the 660 serial port to external equipment with an off-the-shelf DB9 cable, ensure that both I/O channels are either left OFF or set as Inputs if pins 1 or 6 are passed through the cable and that the 660 power input is protected against automotive load-dumps and surges, if applicable, if pin 4 is passed through the cable.

USB Port:



2.4 Mounting a 660

The Model 660 mounts on a quick-detach bracket. Weld or bolt the quick-detach bracket into place, as follows:

1. Choose a mounting location that is:
 - Convenient for the operation of the indicator.
 - Protected from moving parts or from other moving machinery.
2. Hold the indicator at the proposed mounting location and verify that the display is legible and the controls accessible.
3. Positioning the quick-detach bracket with the wider end at the top, mark the desired mounting location. If bolting, use the quick-detach bracket as a template and mark and drill holes.
4. Weld or bolt the quick-detach bracket at the appropriate location. If bolting, use double nuts or self-locking nuts to protect both indicator and machinery.
5. Insert the indicator bracket into the quick-detach bracket and push it down into place.
6. For mobile applications, wrap and twist a strong wire around the indicator bracket and the quick-detach bracket, through the slotted hole provided, to stabilize the mounting. See the illustration below.

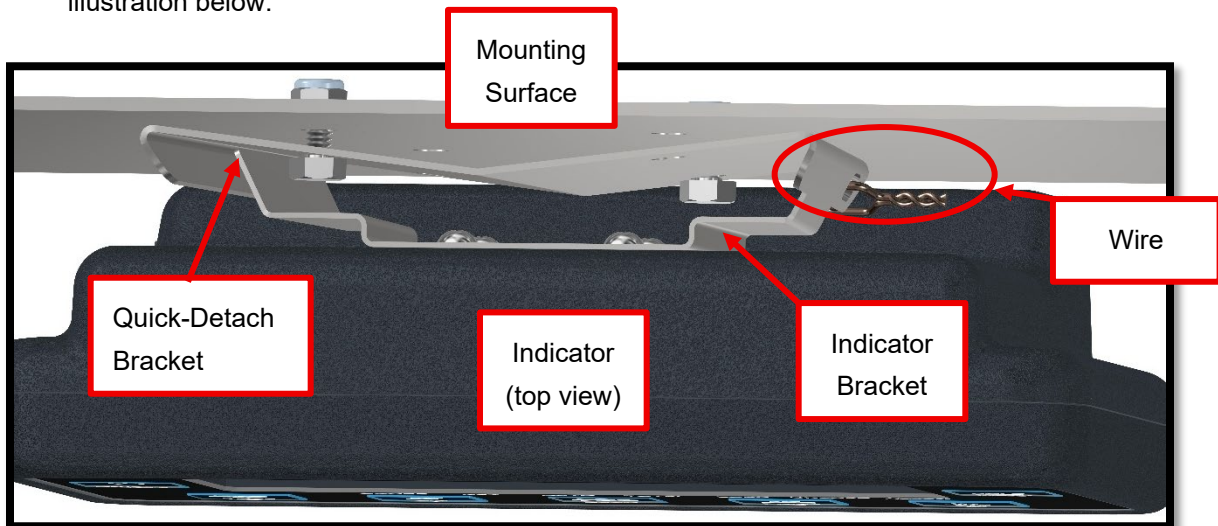

2.5 Powering Up the 660

The 660 power setting can be configured two ways, **Front Panel** (default) activation or **Always On** (this required opening the indicator and installing a jumper).

Front Panel ENTER/POWER Key (default)

With the indicator connected to a power source the indicator will only power up if the **ON/OFF** key is pressed. Once pressed, the indicator will turn on and display a Gross weight reading.

Always On Mode

Once the indicator is connected to a power supply it will automatically power up and remain on until the power source is removed.

1. With the indicator disconnected from its power source, remove the back of the indicator and locate the Always On (P3) circuit (location shown below).

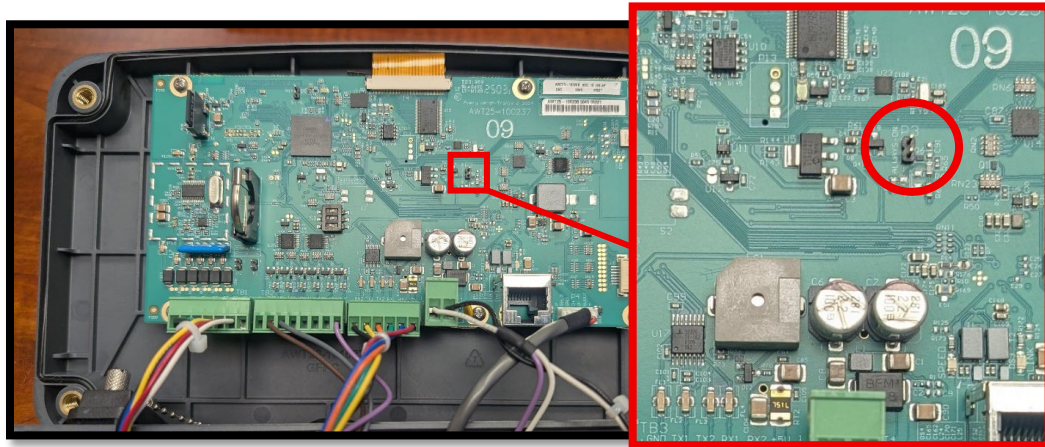

2. Take one of the two provided jumpers and fit it to the circuit (shown below).
3. Reattach the back of the indicator and tighten screws to 11 in/lb. Be careful not to pinch the display ribbon cable and the top of the indicator.
4. Plug the indicator back in. The 660 will now always be powered on and will not turn off the **ON/OFF** key is pressed and held.

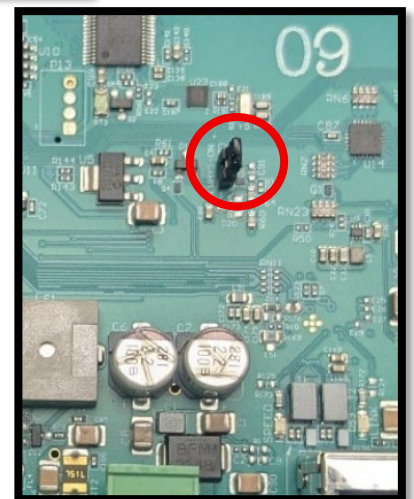
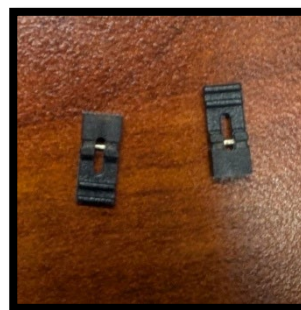

Turning Indicator Off

Press and hold the **ON/OFF** for 5 seconds. Once pressed the display will show a count down from 5 to 0 before turning off. If the **ON/OFF** key is release before the 5 second are up, the indicator will revert to normal operation.

Power Supply Used in the 660

- **External 12-24VDC @ 1.0A** max draw from fully loaded indicator excluding peripherals (8 x 350 load cell), 500mA out the 5V COM port terminal block, 500mA load on USB Host.
- **AC to DC Input Adapter (Optional)** cord connected to a properly grounded outlet (100 VAC – 240 VAC, 50 or 60 Hz)
- If fully powered from a DC power source, like a battery, there are extra power saving features to help prolong battery life found in the Admin Menus. An **Auto shutoff** feature can be activated to automatically turn off the indicator when there are long periods of inactivity.

2.6 Updating the 660

When updating indicator application or firmware the file must be in the root directory of the USB stick. If it is in a folder the indicator will not be able to locate the file. The firmware and indicator application files can be loaded onto the USB stick at the same time.



Note: the latest software versions can be found on agsscales.com/agsscales-documentation-support-files/

2.6.1 Updating the Firmware

1. Ensure the 660 is powered down.
2. Plug in a USB stick with the updated Firmware, and Indicator App into the 660's USB port.
3. Press and hold the **ZERO** and **ON/OFF** keys...
rEIEASE is now displayed.
4. Release the **ZERO** and **ON/OFF** keys...
PLUg is displayed followed by **LOADEr**
5. Press **▶** ...
60.v.X.X.X.X (X=Firmware version number) is now displayed
6. Press **↵** to update the Firmware...
Once updated the indicator will reboot and restart.

2.6.2 Updating the Indicator Application

1. Plug in a USB stick with the updated Firmware, and Indicator App into the 660's USB port.
2. With the indicator powered on, press and hold **HOLD MENU** key...
PASS will briefly display before prompting the user to enter the password
3. Enter the **872** password and press **↵** ...
UpdAtE is now displayed
4. Press **▼** ...
UPd USB is now displayed
5. Use **◀** or **▶** to choose how to update the Indicator Application (via **USB**)
6. Press **▼** to choose the update method.
StANdAr is now displayed
7. Press **↵** to update the Indicator Application.
8. When the indicator finishes updating it asks if you want to override the last calibration. Choose **No** if no calibration update is needed or **YES** if a new calibration is required.
9. Press **↵** to make a selection...
Once updated the indicator will reboot and restart.

3 Introduction

The 660 is a robust and easy-to-use weight indicator designed for agricultural use. The 660 comes in a durable durable glass reinforced plastic enclosure, with a large 1.5" high digit 14 segment HTN LCD display with four color changing backlights, and a chemical resistant numeric keypad. The indicator has one USB port, two RS232 serial COM ports, and Bluetooth connectivity. Using these options, the 660 can connect to USB flash drives, printers, remote displays, computers, mobile devices, and any other peripheral devices via USB, serial, or Bluetooth connections. This indicator also has two onboard logic level setpoints that can be set either as inputs or outputs. The default backlight color for the General Weighing app is Green however the backlight can be disabled from the User menu under the **BackLt** submenu. The available Backlight colors are Green, Red, Yellow, Orange, and Off.



*Note: Users can adjust the backlight brightness and contrast holding the **HOLD MENU** (brightness) or **M+/RM** (contrast) key and use ▲ and ▼ to adjust the settings. The brightness and contrast are saved automatically and will be applied after a reboot.*

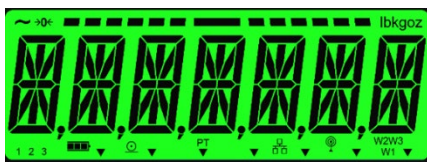

Green



Red

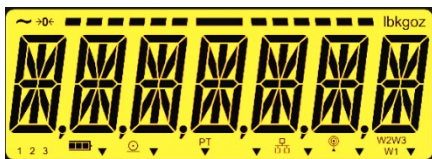

Yellow

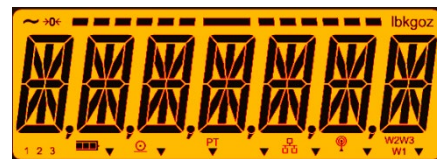

Orange

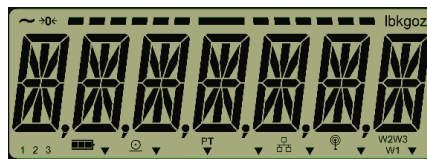

Backlight Off

3.1 Front Panel

The 660 front panel consists of a display and 7 keys.



Note: Never press a key with anything but a finger. Using a sharp or rough object to press a key will cause damage to the overlay.

The normal function of the keys on the front panel are listed below. Some keys will have special functions in certain applications. Details are provided in the individual application sections. In some operator and Supervisor Menus there is a need to navigate up, down, left and right. When in these menus follow the arrows in the blue area of the keys to allow users to move around the menu area.

Key	Function
	<ol style="list-style-type: none"> 1. Short press to save the displayed tare weight. 2. Long press to clear tare weight 3. Acts as the up-arrow key for menu navigation.
	<ol style="list-style-type: none"> 1. Short press cycles from GROSS → NET → GROSS TOTAL for current memory channel 2. Long press lets you change memory channel (200 channels available) 3. Acts as the down-arrow key for menu navigation.
	<ol style="list-style-type: none"> 1. Short press zeros off any weight displayed on the screen. 2. Long press clears the current memory channel.
	<ol style="list-style-type: none"> 1. Short press prints out displayed weight in one of the 10 print formats (Print format 3 is standard from factory) 2. Long press prints report data for current memory channel. 3. Acts as the left-arrow key for menu navigation.
	<ol style="list-style-type: none"> 1. Short press stores displayed weight to current memory channel. 2. Long press removes last weight from current memory channel. 3. Acts as the right-arrow key for menu navigation.
	<ol style="list-style-type: none"> 1. Short press this key to hold a displayed weight. Press again to release the hold mode. The weight is retained in memory in case the unit is turned off. When powered up again the weight reading will still be displayed. This key is also used to move to the right in the menu structure. 2. When AutoLoc is enabled and a weight is locked, a short press unlocks and then re-locks the weight. 3. Long press will prompt you to enter a password. 4. When in a menu it is used as the ESC key
	<ol style="list-style-type: none"> 1. When the indicator is in the OFF state, short press to turn the indicator on. 2. When the indicator is in ON state, long press to turn indicator off (starts countdown and you must hold till countdown gets to OFF) 3. When in a menu it is used as the Enter Key (↵).

3.2 Annunciators

These annunciators will light during operation to inform the user of the weighing mode, active unit of measure, etc. The annunciators on the display are shown below.

Annunciator	Description
G/N	Indicates the unit is in the gross/net weighing mode.
NET	Indicates the unit is in the net weighing mode.
MOTION	Displayed when there is scale motion. This is based off the stability window parameters.
Lb	Indicates the unit is weighing in pounds.
AUTO	Displayed if the unit is programmed for AutoLoc and weight is locked. AutoLoc is used in animal weighing applications.
Kg	Indicates the unit is weighing in kilograms.
Total	Indicates the unit Total function is active.
Load	Indicates the unit is in Load mode.
Unload	Indicates the unit is in Unload mode.
Alarm	Indicates the unit's Alarm function is active.

3.3 Display Messages

Message	Meaning
-----	UPPER DASHES, Indicator is in a state of overcapacity, or analog input is too high.
-----	LOWER DASHES, Indicator is in a state of under capacity, or analog input is too low.
PRINT	Indicator is transmitting data. Appears after pressing the print key for a second.
HOLD	Used when moving a portable system.
+RANGE	Displayed when weight input exceeds 8 mV/V.
-RANGE	Displayed when weight input exceeds -8 mV/V.
CAN'T	Displayed anytime an action cannot be completed.
boundS	Enter not in valid range

3.4 Display Annunciators

These annunciators will light during operation to inform the user of the weighing mode, active unit of measure, etc. The annunciators on the display are shown below.

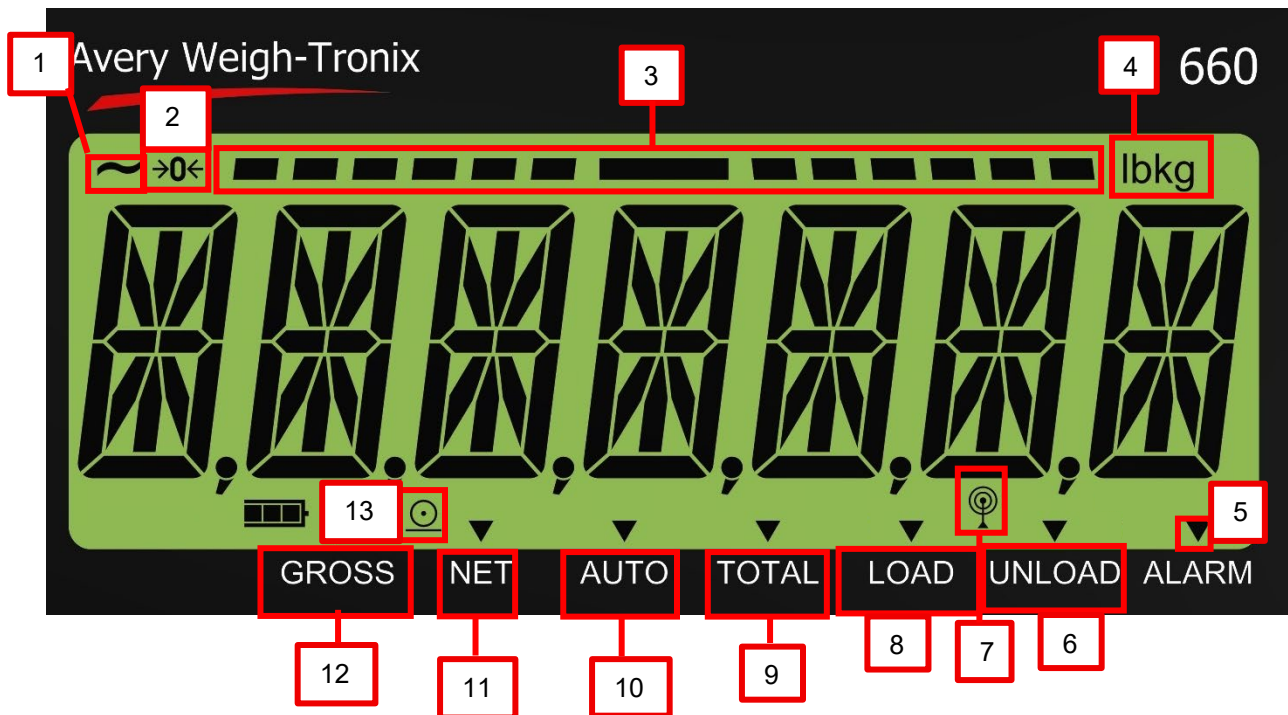

Number	Annunciator	Number	Annunciator
1	Motion	9	Total for Current Memory Channel
2	Center Zero	10	Auto: On when weight is locked.
3	Bar graph	11	Net
4	Units of measure (lb or kg)	12	Gross
5	Alarm	13	Print
6	Unload		
7	Wireless Connection		
8	Load		

3.5 Available Communication ports

To allow the 660 to connect to a wide range of peripheral devices like printers, remote displays, remote bases, PC, phones, and tablets the indicator comes standard with the following connection ports.

- 2 x RS232
- 1 x USB host
- 1 x Bluetooth



Note: When connecting the 660 serial port to external equipment with an off-the-shelf DB9 cable, ensure that both I/O channels are either left OFF or set as Inputs if pins 1 or 6 are passed through the cable and that the 660 power input is protected against automotive load-dumps and surges, if applicable, if pin 4 is passed through the cable.

3.6 Entering Characters

The 660 uses a fourteen segment 7-digit LCD display for displaying navigational menus, however due to the limited keypad it is not ideal for entering alphanumeric text.

When a text entry screen is present scroll through alphanumeric characters and symbols by pressing the ▲ or ▼ keys and move the cursor position by using the ◀ or ▶ keys. Once you have the desired character move the cursor to the next position or press ↵ to accept the input.

3.6.1 Entering Negative Numbers or a Decimal Point

To enter a negative number, press the ▶ key to clear the current value from the display. With only one digit displayed press ▼. The first character will be the (-) negative sign. Enter the rest of the digits normally and press ↵ to accept the input.

3.7 Selecting a Unit of Measure

To switch between Units of Measure, navigate to the Calibration Menu to toggle between the primary units of measure the connected scale is calibrated for (units are lb,kg).



Note: See AWTX Remote Assist mobile app for how to actively switch between units.

The active unit of measure is illuminated in the top right corner of the display (shown below as callout 1).



3.8 Menu Basics

The 660's different menu levels allow users to set up different weighing apps, change available settings. All Menu levels available in the 660 indicator are accessed through passwords. Users can customize and configure the indicator for their purposes from these menus. Use the provided menu maps located in the Menu Sections to navigate to the menu item(s).

The menu levels and their passwords are shown below:

Password	Menu Level	Accessed Menus
111	USER	User, About, Audit
3088	ADMIN	Setup, Diag, User, About, Audit
1793	SUPER	Application specific items.





Some menus appear in multiple menu levels. For example, the 111 password gives access to the **User**, **About**, and **Audit** menus. The 1793 password gives access to the Supervisor Menu. The 3088 password gives access to those four plus the **Setup** menu.

This access structure allows the user to control access to some, or all menus based on the passwords shared.



Please note that menus are the same no matter which menu level they are accessed from.

3.8.1 Accessing Menus

Follow these steps to access the menus in the 660.

1. With the indicator powered up and in normal operating mode, press and hold **HOLD MENU** ...
PASS is now displayed, prompting the user to enter the password.
2. Use the directional arrow keys to enter the password for the needed menu and press  ...
The first item in the top level of the accessed menu is now displayed.
3. Use the navigation keys (, , , or ) to navigate through the menu structure.

3.8.2 Exiting Menus

1. Use **HOLD MENU** to escape and move up one level without accepting the choice or value ...
SAVe No is now displayed. This means "Do not save changes."
2. Press  to scroll through the choices: **SAVe no**, **SAVeYES**, and **CANcEI**. Press  to accept the displayed choice.

Select **SAVe No** or **SAVeYES** to have the indicator exit the current menu and returns to normal weighing mode.

OR

Select **CANcEI** for the indicator to remain in the current menu.

4 Calibration

There are two ways to calibrate the indicator. The traditional way through the Admin Menu and by using the AWTX Remote Assist mobile application.

4.1 Calibration Through Remote Assist Application

Download the Remote Assist app to any smartphone or tablet from either the Google Play Store or the Apple App Store by using the QR Code below.

Google Play Store: [AWTX Remote Assist - Apps on Google Play](#)

Apple App Store: [AWTX Remote Assist on the App Store](#)

OR

Search “AWTX Remote Assist” in either App Store and tap on the Remote Assist App Icon.

Once downloaded, tap the R-Assist icon to launch the application.

4.1.1 Connecting a Scale

1. Tap the R-Assist application icon.
2. Tap “Add Bluetooth Device”

Choose Start scanning: select the Serial Number that corresponds to the desired 660 Indicator.

OR

Use QR code on the back of the indicator. Be sure to scan the Bluetooth Connection sticker on the back right hand side of the indicator.



3. Name the device, while being sure to maintain an easy to remember naming convention.



Note: We recommend that users maintain a reliable naming convention for your units. For example, if there are three farm scales (Named: Grain Cart, Mixer, and Animal Scale), name each unit the same as the equipment it is installed on, so when connecting to an indicator through Remote Assist you will see Grain Cart, Mixer, and Animal Scale.

4. Tap the OK button and the mobile device is connected to the 660 Indicator.

4.2 In-App Calibration

The 660 indicator can be calibrated four different ways in the AWTX Remote Assist Mobile App.

- Using Known Weight
- Manual Input Calibration
- Calibration Diameter
- Ag Configuration (Legacy Calibration)

Follow the steps below to use Remote Assist to calibrate a 660.

1. From the home screen, tap the Menu Button in the upper left corner of the screen.
2. Select the Service Menu option.
3. Enter the Remote Assist Admin Password (**3088**) and tap the OK button.



Note: if the Indicator's Admin Password changes the Remote Assist Admin password will also change automatically.

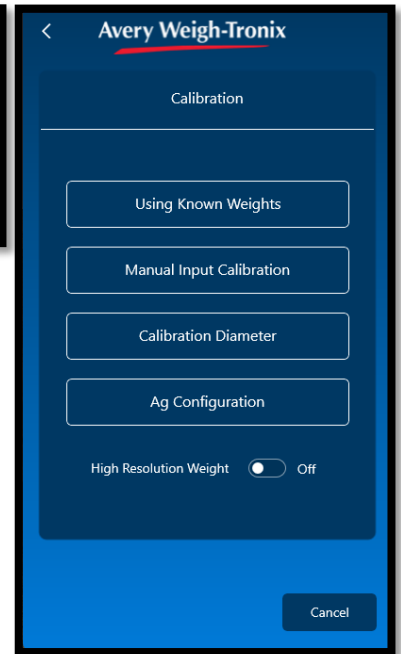
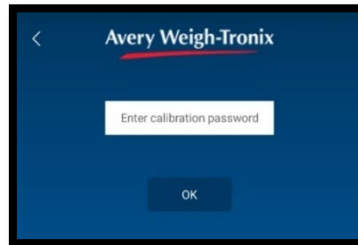

4.2.1 Using Known Weights

1. From the Calibration Menu, tap on the Using Known Weights button.
2. Tap the Zero button
3. Remove all weight from the scale and tap the Send Zero button.

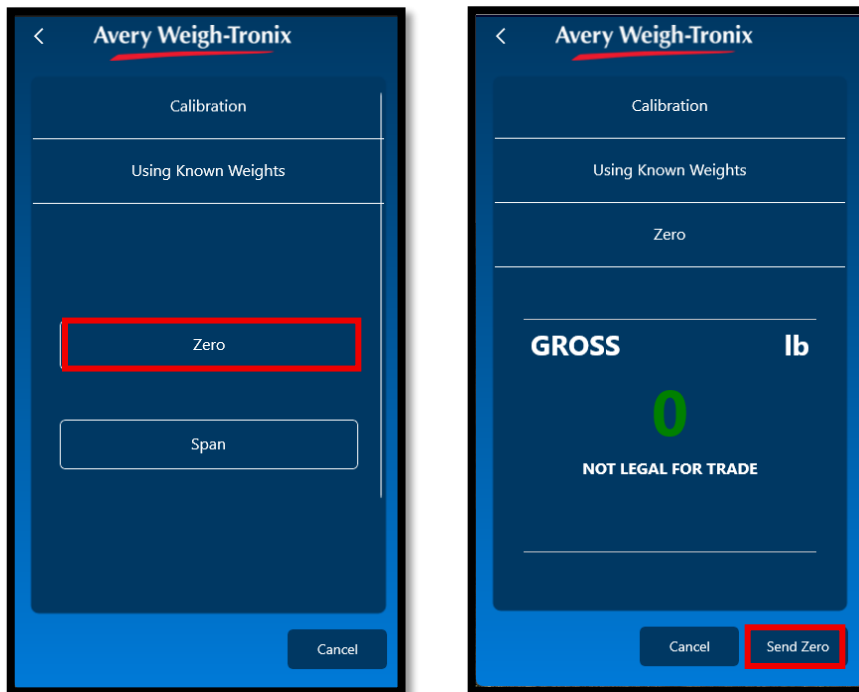

4. From the Service Menu, tap the Using Known Weights button and then the Span button.
5. Choose the desired Unit of Measure.
6. Enter the known Calibration Weight in the provided field.
7. Tap the Send Span button...

If the calibration is successful, the message "Calibration completed!" will appear. Tap the OK button to accept.

OR

Tap Cancel or the back arrow to back out of the Calibration Menu.

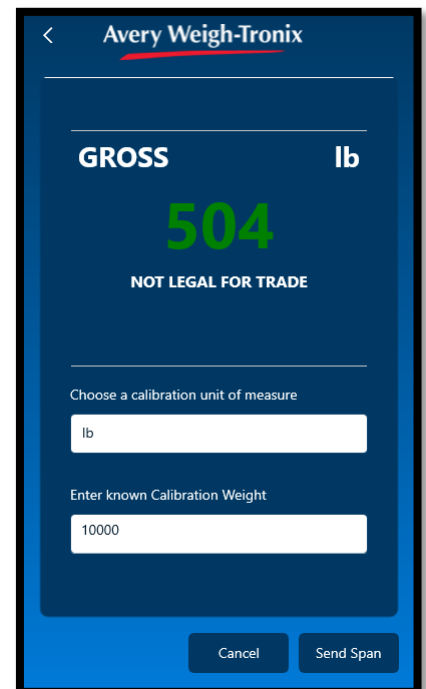

4.2.2 Manual Input Calibration

1. From the Calibration Menu, tap on the Manual Input Calibration button.
2. Choose the number of Weigh Bars in the connected scale.
3. Now scroll down the page to view the new fields: Unit of Measure, mV/V, and Load Rating
4. Chose the desired Unit of Measure to calibrate the indicator with.
5. Enter the mV/V value from the label into the second field. For example: .4 mV/V
6. Enter the Weigh Bar's Load Rating from the label into the third field. Add Example: XX mV/V at 10,000 lbs (load rating at the above mV/V)
7. Tap the Send Span button...
If the calibration is successful, the message "Calibration completed!" will appear. Tap the OK button to accept.

OR

Tap Cancel or the back arrow to back out of the Calibration Me

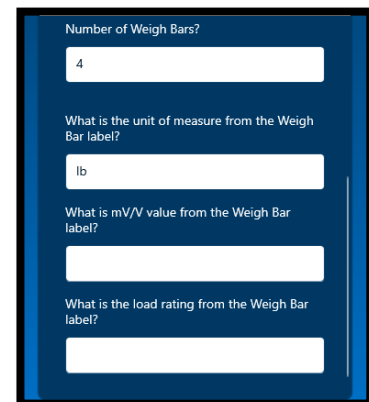
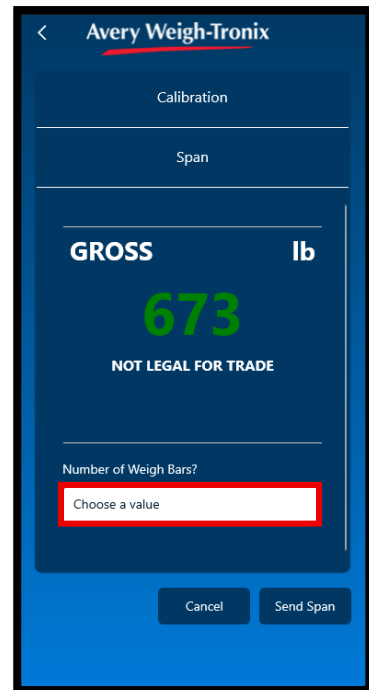

4.2.3 Calibration Diameter

1. From the Calibration Menu, tap on the Calibration Diameter button.
2. Choose the number of Weigh Bars that the indicator is connected to.
3. Choose the Calibration Diameter from the label.
4. Tap the Send Span button...
If the calibration is successful, the message "Calibration completed!" will appear. Tap the OK button to accept.

OR

Tap Cancel or the back arrow to back out of the Calibration Menu.

4.2.4 Ag Calibration or “Legacy Calibration”

1. Tap the Ag Calibration button
2. Enter a Configuration Number into the Config Code field shown or a Custom Configuration Number into the Custom Code Field.

The default Configuration Number is **05130**. This means that out of the box the 660 is setup for 2 1/8 CAL with a capacity of 20,000lbs, division size of 2 lbs, Print Format GTN W/TD, units set to LBS, and Auto Accum/AutoLoc set to off. This is for a four-bar system.

3. Tap the Send Config button.
4. If the Config Code is not known, use the sections below to determine one.



Note: This section calibrates the indicator in the traditional manner like our legacy series of indicators. If you know your configuration number/s this will be entered the same way here.

4.3 Determine the Configuration Number

This section shows you how to find and enter a configuration number that sets up the indicator for the following: type of Weigh Bar, capacity, increment, and units.

The following are instructions for how to determine what number needs to be entered into the calibration configuration number menu.

Example: 2 1/8 calibration, 20,000 (capacity limit) x 5 (increments the scale counts in), Print GTN with time/date, unit = kg with AutoLoc off and Auto-Acc on.

Configuration code = 05235

1. The first two digits are the calibration size. In our example the calibration size is **2 1/8**. The corresponding number is shown below. Find the desired calibration size. In this example, **05** are the first two digits.

1st and 2nd Digit	CALIBRATION SIZE	CAPACITY x INCREMENT SIZE					
03	1-7/8	20K x 1	20K x 2	20K x 5	200K x 10	200K x 20	200K x 50
04	2	20K x 1	20K x 2	20K x 5	200K x 10	200K x 20	200K x 50
05	2-1/8	20K x 1	20K x 2	20K x 5	200K x 10	200K x 20	200K x 50
06	2-1/4	20K x 1	20K x 2	20K x 5	200K x 10	200K x 20	200K x 50

2. The third digit is the capacity and increment size within the calibration size. In this example **20,000 x 2** is being used. Follow the row of the chosen calibration size (i.e. 05) until you find the desired capacity and increment size. Follow the column down to the bottom row. The third digit is located on the bottom row. For this example, **2** is the number.

1st and 2nd Digit	CALIBRATION SIZE	CAPACITY x INCREMENT SIZE					
03	1-7/8	20K x 1	20K x 2	20K x 5	200K x 10	200K x 20	200K x 50
04	2	20K x 1	20K x 2	20K x 5	200K x 10	200K x 20	200K x 50
05	2-1/8	20K x 1	20K x 2	20K x 5	200K x 10	200K x 20	200K x 50
3rd DIGIT		0	1	2	3	4	5

3. The fourth digit is for the print format. In the example we used **3** for Gross, Tare, Net with Time and Date.
4. The fifth digit is used for the calibration unit (lb or kg) along with AutoLoc and auto-acc. For this example, **5** is used.

4.3.1 Configuration Codes

The following tables show how to establish a Configuration Code Number (CCN) to configure the 660 indicator. The table below applies to all 3 Weigh Bar junction box systems and 4 Weigh Bar junction box systems.

- The only exception is the Calibration Size 2 1/4D-P, which can be used with 8 Weigh Bars that are 2 1/4 D cal size.
- If you use any other number of Weigh Bars, use custom settings 97, 98, or 99 and refer to the Custom Configuration Number for AWTX Weighbars section below to find your configuration numbers based on reading of .4mV/V.

1st and 2nd Digit	CALIBRATION SIZE	CAPACITY x INCREMENT SIZE					
		200 x 0.01	200 x 0.02	200 x 0.05	2K x 0.1	2K x 0.2	2K x 0.5
00	5/8	200 x 0.01	200 x 0.02	200 x 0.05	2K x 0.1	2K x 0.2	2K x 0.5
01	1	2K x 0.1	2K x 0.2	2K x 0.5	20K x 1	20K x 2	20K x 5
02	1-1/4	2K x 0.1	2K x 0.2	2K x 0.5	20K x 1	20K x 2	20K x 5
03	1-7/8	20K x 1	20K x 2	20K x 5	200K x 10	200K x 20	200K x 50
04	2	20K x 1	20K x 2	20K x 5	200K x 10	200K x 20	200K x 50
05	2-1/8	20K x 1	20K x 2	20K x 5	200K x 10	200K x 20	200K x 50
06	2-1/4	20K x 1	20K x 2	20K x 5	200K x 10	200K x 20	200K x 50
07	2-1/4D	20K x 1	20K x 2	20K x 5	200K x 10	200K x 20	200K x 50
08	2-1/4D-P	200K x 10	200K x 20	200K x 50	200K x 100	200K x 200	200K x 500
09	2-1/2	20K x 1	20K x 2	20K x 5	200K x 10	200K x 20	200K x 50
10	3-1/8	200K x 10	200K x 20	200K x 50	200K x 100	200K x 200	200K x 500
11	4	200K x 10	200K x 20	200K x 50	200K x 100	200K x 200	200K x 500
12	CC20/CC30	20K x 1	20K x 2	20K x 5	200K x 10	200K x 20	200K x 50
13	Alley Weigh	2K x 0.1	2K x 0.2	2K x 0.5	20K x 1	20K x 2	20K x 5
14	CC30-3	20K x 1	20K x 2	20K x 5	200K x 10	200K x 20	200K x 50
15	Chute Weigh	20K x 1	20K x 2	20K x 5	200K x 10	200K x 20	200K x 50
16	CC-50	200K x 10	200K x 20	200K x 50	200K x 100	200K x 200	200K x 500
18	SPARE	20K x 1	20K x 2	20K x 5	200K x 10	200K x 20	200K x 50
20	1-digi	2K x 0.1	2K x 0.2	2K x 0.5	20K x 1	20K x 2	20K x 5
21	1 POLY(DIGI)	20K x 1	20K x 2	20K x 5	200K x 10	200K x 20	200K x 50
22	1-7/8,2(DIGI)	20K x 1	20K x 2	20K x 5	200K x 10	200K x 20	200K x 50
23	2-1/8,2-1/2,2-7/8,3-3/4 (DIGI)	20K x 1	20K x 2	20K x 5	200K x 10	200K x 20	200K x 50
97	Custom Setting	200 x 0.01	200 x 0.02	200 x 0.05	2K x 0.1	2K x 0.2	2K x 0.5
98	Custom Setting	20K x 1	20K x 2	20K x 5	200K x 10	200K x 20	200K x 50
99	Custom Setting	200K x 100	200K x 200	200K x 500	-	-	-
3rd DIGIT		0	1	2	3	4	5

The fourth digit of the Configuration Code Number (CCN). The 660 has ten choices for print outs.

4th Digit	Print Formats	
1	GTN	
2	G w/ TD	
3	GTN w/TD (STD)	Default for 660
4	CSV-G	
5	CSV-GTN	
6	CSV-G w/TD	
7	CSV-GTN w/TD	
8	Displayed Wt.	
9	Displayed Wt. w/TD	
10	G	

The fifth digit is used for the calibration unit (lb or kg) along with AutoLoc and auto-acc. For this example, 5 is used.

5th Digit	Units	AutoLoc	Auto-Acc	
0	lb	OFF	OFF	Default for 660
1	lb	OFF	ON	
2	lb	ON	OFF	
3	lb	ON	ON	
4	kg	OFF	OFF	
5	kg	OFF	ON	
6	kg	ON	OFF	
7	kg	ON	ON	

4.3.2 Configuration Code Numbers for Common Applications:

TMR MIXERS:

2 1/8 inch calibration weigh bar	20,000 x 5 lb	(5230)
2 1/2 inch calibration weigh bar	200,000 x 10	(9330)
2 1/4D calibration weigh bar	200,000 x 10 lb	(7330)
CC-30 Compression Cell	200,000 x 10 lb	(14330)

GRAIN CARTS:

2 1/4D calibration weigh bar	200,000 x 20 lb	(7430)
CC-30 Compression Cell	200,000 x 20 lb	(14430)

LIVESTOCK:

2 1/8 inch calibration weigh bar	20,000 x 1 lb	(5030)
Chute Weigh System	20,000 x 1 lb	(15030)
Alley Weigh System	2,000 x 1 lb	(13330)

If it is impossible to know exactly which weigh bars are on the scale system, try one of the recommended Configuration Code Numbers and keep entering code numbers until the scale appears to be weighing properly. (See section below entitled: Entering A New Configuration Code Number)

After several attempts at a code number, if the scale still does not weigh properly, please consider the following:

- Contact your dealer or distributor where the scale was purchased.
- Access the Avery Weigh-Tronix website at www.agscales.com for more debugging tips.
- Contact the Avery Weigh-Tronix service department at 1-800-458-7062 for assistance.

4.3.3 Determining a Configuration Number

The following are instructions for how to determine what number needs to be entered into the calibration configuration number menu.

Example: 6 2 1/2 calibration, 200,000 (capacity limit) x 20 (increments the scale counts in), Print GTN with time/date, unit = kg with AutoLoc off and Auto-Acc on.

1. In our example, 6 weigh bars are being used so the custom number must be matched up with the Capacity and Increment Size. The Capacity and Increment Size is **200K x 20**. Find the custom setting number by following the row of the desired Capacity and Increment Size. In this example, **98** are the first two digits.

97	Custom Setting	200 x 0.01	200 x 0.02	200 x 0.05	2K x 0.1	2K x 0.2	2K x 0.5
98	Custom Setting	20K x 1	20K x 2	20K x 5	200K x 10	200K x 20	200K x 50
99	Custom Setting	200K x 100	200K x 200	200K x 500	-	-	-

2. The third digit is the Capacity and Increment Size within the custom setting. In this example **200,000 x 20** is being used. Follow the column down to the bottom row. The third digit is located on the bottom row. For this example, **4** is the number.

97	Custom Setting	200 x 0.01	200 x 0.02	200 x 0.05	2K x 0.1	2K x 0.2	2K x 0.5
98	Custom Setting	20K x 1	20K x 2	20K x 5	200K x 10	200K x 20	200K x 50
99	Custom Setting	200K x 100	200K x 200	200K x 500	-	-	-
3rd DIGIT		0	1	2	3	4	5

3. The fourth digit is for the print format. In the example we used **3** for Gross, Tare, Net with Time and Date.
4. The fifth digit is used for the calibration unit (lb or kg) along with AutoLoc and auto-acc. For this example, **5** is used.
5. *Making the Configuration code = **98435***

4.3.4 Determining a Custom Calibration Number

Use the table below to determine a Custom Calibration Number. See the steps below to understand how to use the Custom Calibration Number Table.

1. First you go down left-hand column (Cal Size) and find **2.5**.
2. Next, in the 2nd column find **6** for 6 weigh bars.
3. The fourth column (kg) **17490** is the custom number.

2.5	5	32133	14575
2.5	6	38559	17490
2.5	7	44986	20405



Note: When using Custom Configuration, you must use test weights or verify a load on another scale.

4.3.5 Custom Calibration Number Table

Cal Size	Number of Bars	Custom # (lb) @.4mV/V	Custom # (kg) @.4mV/V
5/8	1	92.3	41.8
5/8	2	184.5	83.7
5/8	3	276.8	125.5
5/8	4	369	167.4
5/8	5	461.3	209.2
5/8	6	553.6	251.1
5/8	7	645.8	292.9
5/8	8	738.1	334.8
1	1	375.3	170.2
1	2	750.6	340.5
1	3	1126	510.7
1	4	1501.3	681
1	5	1876.6	851.2
1	6	2251.9	1021.5
1	7	2627.2	1191.7
1	8	3002.6	1361.9
1.25	1	893	405
1.25	2	1785.9	810.1
1.25	3	2678.9	1215.1
1.25	4	3571.9	1620.2
1.25	5	4464.9	2025.2
1.25	6	5357.8	2430.3
1.25	7	6250.8	2835.3
1.25	8	7143.8	3240.4
1.875	1	2630	1193
1.875	2	5261	2386
1.875	3	7891	3579
1.875	4	10522	4773
1.875	5	13152	5966
1.875	6	15782	7159
1.875	7	18413	8352
1.875	8	21043	9545
2	1	3270	1483

Cal Size	Number of Bars	Custom # (lb) @.4mV/V	Custom # (kg) @.4mV/V
2	2	6540	2967
2	3	9810	4450
2	4	13080	5933
2	5	16350	7416
2	6	19620	8900
2	7	22890	10383
2	8	26160	11866
2.125	1	3753	1702
2.125	2	7506	3405
2.125	3	11260	5107
2.125	4	15013	6810
2.125	5	18766	8512
2.125	6	22519	10215
2.125	7	26272	11917
2.125	8	30026	13619
2.25	1	4613	2092
2.25	2	9226	4185
2.25	3	13839	6277
2.25	4	18452	8370
2.25	5	23065	10462
2.25	6	27678	12554
2.25	7	32291	14647
2.25	8	36904	16739
2 1/4Dual	1	9226	4185
2 1/4Dual	2	18452	8370
2 1/4Dual	3	27678	12554
2 1/4Dual	4	36904	16739
2 1/4Dual	5	46130	20924
2 1/4Dual	6	55356	25109
2 1/4Dual	7	64582	29294
2 1/4Dual	8	73808	33479
2.5	1	6427	2915
2.5	2	12853	5830
2.5	3	19280	8745
2.5	4	25706	11660
2.5	5	32133	14575

Cal Size	Number of Bars	Custom # (lb) @.4mV/V	Custom # (kg) @.4mV/V
2.5	6	38559	17490
2.5	7	44986	20405
2.5	8	51412	23320
3.125	1	12955	5876
3.125	2	25910	11752
3.125	3	38864	17629
3.125	4	51819	23505
3.125	5	64774	29381
3.125	6	77729	35257
3.125	7	90684	41133
3.125	8	103638	47010
4	1	26523	12031
4	2	53046	24061
4	3	79569	36092
4	4	106092	48122
4	5	132615	60153
4	6	159137	72184
4	7	185660	84214
4	8	212183	96245
Alley Weigh bar	1	389	176
Alley Weigh bar	2	778	353
Alley Weigh bar	3	1167	529
Alley Weigh bar	4	1556	706
Alley Weigh bar	5	1946	882
Alley Weigh bar	6	2335	1059
Alley Weigh bar	7	2724	1235
Alley Weigh bar	8	3113	1412
Chute Weigh bar	1	2630	1193
Chute Weigh bar	2	5261	2386
Chute Weigh bar	3	7891	3579
Chute Weigh bar	4	10522	4773
Chute Weigh bar	5	13152	5966
Chute Weigh bar	6	15782	7159
Chute Weigh bar	7	18413	8352
Chute Weigh bar	8	21043	9545
CC-20/CC-30 (2.13 mv/V)	1	5634	2555

Cal Size	Number of Bars	Custom # (lb) @.4mV/V	Custom # (kg) @.4mV/V
CC-20/CC-30 (2.13 mv/V)	2	11268	5111
CC-20/CC-30 (2.13 mv/V)	3	16901	7666
CC-20/CC-30 (2.13 mv/V)	4	22535	10222
CC-20/CC-30 (2.13 mv/V)	5	28169	12777
CC-20/CC-30 (2.13 mv/V)	6	33803	15333
CC-20/CC-30 (2.13 mv/V)	7	39437	17888
CC-20/CC-30 (2.13 mv/V)	8	45070	20444
CC-30 (3.00 mv/V)	1	4000	1814
CC-30 (3.00 mv/V)	2	8000	3629
CC-30 (3.00 mv/V)	3	12000	5443
CC-30 (3.00 mv/V)	4	16000	7257
CC-30 (3.00 mv/V)	5	20000	9072
CC-30 (3.00 mv/V)	6	24000	10886
CC-30 (3.00 mv/V)	7	28000	12701
CC-30 (3.00 mv/V)	8	32000	14515
CC-50 (2.50 mv/V)	1	8000	3629
CC-50 (2.50 mv/V)	2	16000	7257
CC-50 (2.50 mv/V)	3	24000	10886
CC-50 (2.50 mv/V)	4	32000	14515
CC-50 (2.50 mv/V)	5	40000	18144
CC-50 (2.50 mv/V)	6	48000	21772
CC-50 (2.50 mv/V)	7	56000	25401
CC-50 (2.50 mv/V)	8	64000	29030

4.3.6 Configuring the 660 for Other Brand Weigh Bars and Loadcells

The 660 will work with any brand of strain gage-based weigh bar or load cell. Once the system is installed, the 660 will then need to be calibrated. This can be accomplished by placing a known weight on the scale and then calculating the sensitivity output based on information from the weigh bar or load cell that can be directly entered into the indicator.

In the case of brands other than Avery Weigh-Tronix, we recommend using the AWTX Remote Assist Mobile App to give you the most options to calibrate.

4.3.7 Determine Custom Calibration Number

Now a Custom Calibration Number needs to be calculated. This can be derived by two methods; either get the information from the weigh bars that are being used as shown here:

Example 1:

Need to calibrate to 4 weigh bars with the following information: 1 weigh bar
 $2.0 \text{ mv/V} = 5,000 \text{ lb}$

Therefore 4 weigh bars would be $2.0 \text{ mv/V} = 20,000 \text{ lb}$ for the system.

$$5000\text{lb (weigh bar capacity)} \times 4 \text{ (number of weigh bars)} = \mathbf{20,000}$$

Next is to figure out the custom number per 0.4 mv/V

$$2.0 \text{ mv/V (mv/V of weigh bar)} / 0.4 \text{ mv/V (custom number mv/V)} = \mathbf{5 \text{ mv/V}}$$

$$20,000 \text{ (total capacity of weigh bars)} / 5 \text{ (mv/V answer from above)} = \mathbf{4000}$$

The custom number would be the weight value at 0.4 mv/v or as in this example 4000 lb.

OR

The other method is to first enter in the Configuration Code Number and then place a known weight on the scale. Record that weight and then figure the scale factor difference from the known weight and the displayed weight. Then this factor needs to be multiplied by the current Custom Number to calculate the new Custom Number.

Example 2:

Current Custom configuration Code = 4000	Known Weight Applied	15,000
660	Displayed Weight	10,000

$$15,000 \text{ (Known Weight Applied)} / 10,000 \text{ (660 Displayed Weight)} = \mathbf{1.5}$$

$$\text{(Current CUSTOM \#)} \times \text{(Calibration Factor)} = \text{(New CUSTOM \#)} \quad 4000 \times 1.5 = \mathbf{6000}$$

Therefore, go to the Custom Calibration setting in the SETUP menu and change as needed.

4.4 Ag Calibration from the Indicator

Setup ↓ Calib ↓ Scale 1 ↓ Zero → Span → Linear → Build.Up → Input → Gravity → Display → Cal.Unit → Print → CF9.NuM

1. On the 660 indicators, press and hold **HOLD MENU** ...
PASS is briefly displayed.
2. Enter the **3088** password...
SEtuP is now displayed.
3. Press ▼ ...
Calib is now displayed.
4. Press ▼ ...
Scale 1 is now displayed.
5. Press ▼ ...
Zero
6. Press ► ...
SPAN is now displayed.
7. Press ► ...
LINEAr is now displayed.
8. Press ► ...
build.UP is now displayed.
9. Press ► ...
INPut is now displayed.
10. Press ► ...
GrAvity is now displayed.
11. Press ► ...
diSPIAy is now displayed.
12. Press ► ...
Cal.UNit is now displayed.
13. Press ► ...
PriNt is now displayed.
14. Press ► ...
CF9 NuM is now displayed.
15. Press ▼ ...
05130 is now displayed. The default Configuration Number is 05130. This means that out of the box the 660 is setup for 2 1/8 CAL with a capacity of 20,000lbs, division size of 2 lbs, Print Format GTN W/TD, units set to LBS, and Auto Accum/AutoLoc set to off. This is for a four-bar system.
16. Enter a configuration code or create a custom number. See previous section for instructions on determining codes ([page 27](#)) or creating custom codes ([page 31](#)), starting on.
17. Press ← to accept the displayed Configuration Number...
CF9 NuM is now displayed
18. Press ▲ repeatedly until **SAVe No** is displayed
19. Press ► ...
SAVeES is now displayed
20. Press ← to save the new Configuration Number.
21. Press ► from **CF9 NuM** to access the **CuST.CF9** menu.
When using a Custom Configuration Number that starts with 97, 98, or 99 **CuST.CF9** menu option will appear after **CF9 NuM**.

4.5 Indicator Calibration via the Admin Menu

4.5.1 Calibration Zero Procedure (Used When Calibrating with Known Weights)

Calib ↓ Scale 1 ↓ Zero

Zero: This allows users to access the scale zeroing process. On the initial Zero Calibration of the indicator, the zero cal counts may appear unstable. Continue to the span calibration and when completed the condition should correct itself.

Cal.Zero: This allows users to record a zero point. Follow the provided menu map to complete the zero calibration.

There are four ways to calibrate the indicator:

- **The Admin Menu 3088:** Used for known weight calibration and Legacy type calibration.
- **Remote Assist Mobile App Calibration:** from the Remote Assist Mobile App the scale can be recalibrated directly from the mobile app. See the Remote Assist Mobile App Calibration instruction on.

Last Used Zero: If certified test weights are placed on the scale display a slightly inaccurate value be sure that the scale is zeroed before adding the test weights and enter the calibration procedure and Select Last Zero. The last acquired zero value will be assigned as the new Cal Zero value. Continue to the SPAN procedure without removing the test weights. Enter the value of the test weights on the scale and complete the SPAN procedure. The test weights will now be weighted accurately.

Temporarily Zero: Use when the product weight on the scale, such as in a tank or vessel, appears to be inaccurate but cannot be removed. Enter the calibration procedure and select Temp Zero. The current weight on the scale will be temporarily assigned as the Cal Zero value. Continuing to the SPAN procedure, enter the value of the test weights and place them on the scale and complete the SPAN procedure. The original Cal Zero is restored after exiting the span procedure and the current product weight will now be correctly represented. Due to factors that created the original inaccuracy, it may be necessary to re-zero the scale when the tank or vessel is empty.

All methods of calibration automatically log in to the Calibration Counter once the new calibration data is saved.

1. From **Calib** press ▼ ...
ScALE 1 is now displayed
2. From **ScALE 1** press ▼ ...
ZERo is now displayed.
3. Press ▼ again ...
cAL.ZERo is now displayed. Use this to record the zero point.
4. To perform a Zero Calibration, from the **cAL.ZERo** display, press ▼ ...
C 0 is now displayed. The **c** denotes the fact you are in the calibration procedure. The numeric value is the current weight value seen by the indicator.
5. Remove all weight from the scale and press ← ...
buSy is briefly displayed and if the procedure was successful, the indicator will display **C 0** is displayed. If not successful, repeat steps 3 and 4.
6. Press ← ...
cAL.ZERo is now displayed.
7. Enter the calibration procedure and select Temp. zero...
The current weight on the scale will be temporarily assigned as the Cal Zero value.
8. Continue to the SPAN procedure, enter the value of the test weights and place them on the scale and complete the SPAN procedure.
9. The original Cal Zero is restored after exiting the span procedure and the current product weight will now be correctly represented. Due to factors that created the original inaccuracy, it may be necessary to re-zero the scale when the tank or vessel is empty.
10. Unless further Zero Calibration is required, continue to the Span Procedure.

4.5.2 Span Procedure (Used When Calibrating with Known Weights)

Calib ↓ Scale 1 ↓ Zero → Span

Span: This allows users to set the Span Calibration point. Press the ▼ and XXXX is now displayed with a flashing right digit. This is the current span weight.

1. From **cAL.ZEro** display, press ▲ ...
Zero is now displayed.
2. Press ► ...
SPAn is now displayed.
3. Press ▼ to span the scale ...
XXXX is now displayed with a flashing right digit.
4. Press ↵ to accept the displayed span weight or enter your new span weight (not to exceed the configured capacity) and press ↵ ...
C 0 is now displayed. This is the current weight on the scale. The **c** is a reminder that you are in the calibration procedure.
5. Place the span weight on the scale and press ↵ ...
buSy is briefly displayed and then **c XXXX** is displayed, which should be the same as the span weight you keyed in. The span procedure is complete.
6. Press ↵ ...
SPAn is now displayed.

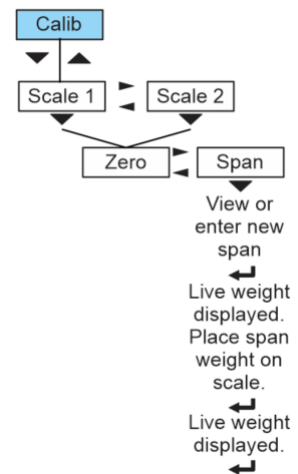

5 Basic Operations for General Weighing

5.1 Zero

When the indicator displays any value other than 0 without a load, press the **ZERO** key to reset the indicator and scale base to 0.

5.2 Gross Weighing

To perform gross weighing, power up the indicator and follow these steps:

1. Empty the scale and press **ZERO** to zero the scale ...
0 is now displayed and the center-of-zero GROSS annunciator lights up.
2. Place the item to be weighed on the scale...
The items weight is now displayed.
3. Remove the item from the scale.
4. Repeat steps 2 and 3 for each new item to be weighed.

5.3 Tare

Designed to remove or “tare-off” the weight of a container on this scale so only the goods/items inside the container are weighed. The weight of goods placed inside the container are displayed as a Net weight. Press the **G/N** key to toggle the display between the Gross, Net, and Tare weighs.

Net Weighing

Net weighing allows users to see the weight of item/items without the weight of the container holding them factored in.

Using Pushbutton Tare

To perform a net weighment using Pushbutton Tare, power up the indicator and follow these steps:

1. If the display does not read 0 with nothing on the scale press **ZERO** ...
0 is now displayed and the center-of-zero annunciator lights.
2. Place item to be tared-off on the scale (often a container) ...
Weight is now displayed.
3. Press **TARE** ...
0 is now displayed and the Net annunciator lights up.
4. Place material to be weighed into or on the tared item on the scale ...
Net weight of material is now displayed.
5. Repeatedly press **G/N** to cycle the Gross, Tare, and Net values.
6. If repeated weighments use the same tared item, do not establish a new tare value as described in step 2 and 3.

Clearing a Tare

Press and hold the **TARE** key. The scale display **Cleared** and the Gross annunciator will illuminate.

5.4 G/N Key Function

Pressing the **G/N** key allows users to cycle through and view the values. If an accumulation function is turned on and the scale is within the Gross Zero weight band, pressing the **G/N** key also shows the Gross, Net, and Gross Totals.

- When the Gross Total is displayed, both the GROSS and TOTAL annunciators will be lit. Additionally, when in normal operation the user can hold down the **G/N** key to change accumulation channel.

5.5 Printing

To print the current weight information, press the **PRINT** key. The configured print format will be outputted through the configured port to the connected peripheral device.

The 660 comes standard with a library of ten predefined formats suitable for most applications.

UDFs (User Defined Fields) hold printable data that can be modified and amended from the Remote Assist Mobile App for use on print tickets or labels to add in customer required data that may change per label batch.

Changing the Print Format

- Press and hold **HOLD MENU** ...
Pass is briefly displayed before the text input prompt
- Enter the Supervisor Menu Password (1793) and press **↵** ...
Super is now displayed
- Press **▼** ...
Ld-Unld is now displayed
- Press **▶** ...
AccuM is now displayed.
- Press **▶** ...
AutoLoc is now displayed.
- Press **▶** ...
INPut is now displayed.
- Press **▶** ...
PForMAt is now displayed.
- Press **▼** ...
3 (system default) is now displayed.
- Enter the desired Print Format Number and press **↵** ...
The Print Format has now been updated and **PForMAt** is now displayed.
- Press **▲** repeatedly until **SAVe No** is displayed.
- Press **▶** to scroll through the choices: **SAVe No**, **SAvEYES**, and **CANcEI**. Press **↵** to accept the displayed choice.

Example Print Format:

Gross	1495 lb
Tare	2455 lb
Net	-960 lb
04:51:10	05-02-2025

Select **SAVe No** or **SAvEYES** to have the indicator exit the current menu and returns to normal weighing mode.

OR

Select **CANcEI** for the indicator to remain in the current menu.

5.6 Load Unload

The Load Unload procedure allows the user to load/unload a series of net amounts. It is ideal for TMR mixers, weigh carts, grain carts, etc. for viewing and recording net amounts of material loaded and unloaded.



Note: When LOAD/UNLOAD is enabled, it will disable AUTOLOC and AUTOACC if they are enabled.

5.6.1 Load Unload Setup

Super ↓ Ld-Unld

1. Press and hold **HOLD MENU** ...
Pass is briefly displayed before the text input prompt
2. Enter the Supervisor Menu Password (1793) and press **↵** ...
Super is now displayed
3. Press **▼** ...
Ld-Unld is now displayed

On/Off

Load Unload is turned off by default. To turn it on, follow the steps below.

4. Press **▼** ...
ON/OFF is now displayed.
5. Press **▼** ...
OFF is now displayed.
6. Use **◀** and **▶** to cycle through the print options (**On** and **Off**)
7. When **ON** is displayed, press **↵** ...
Load Unload is now activated, and **ON/OFF** is now displayed.

Alarm Percent

8. Press **▶** ...
AlrMPeR is now displayed.
9. Press **▼** ...
Enter the percent required to trigger an alarm.
10. Press **↵** ...
AlrMPeR is now displayed.

Target Weight

11. Press **▶** ...
TargET is now displayed.
12. Press **▼** ...
Enter the desired Target Weight
13. Press **↵** ...
TargET is now displayed.

5.6.2 Load Unload Operations

1. Set Target Weight set.
2. Press the **M+/RM** key to change target weight.
3. Check to see that the annunciator at the bottom of the display is pointed to the operation you want to perform.
4. Press and hold the **M+/RM** key to switch between LOAD/UNLOAD.
5. Use **◀** or **▶** to toggle from load to unload and press **↵** to make a selection.
6. Begin to Load or Unload weight.
7. The display will change from Green to Red when the weight is within set alarm percentage of the target weight.
8. Press the **PRINT** or **TARE** keys to reset the target weight. **PRINT** will also print the current loaded or unloaded weight.

If no printer is connected, the printed information will go to the internal memory until a USB is plugged into the indicator. The indicator will then transfer the file to the USB and erase it from the internal memory. This is a one-time action.

Default Print Format:

```
LOAD:      1140 lb
UNLOAD:    -1140 lb
```

5.7 Auto Accumulation

Auto Accumulation can be used anytime you want to do multiple weighments and store them to the current selected memory channel. This allows users to save multiple weighments to be stored, averaged, and a report to be printed.

5.7.1 Auto Accumulation Setup

Example Print Format:

```
02:08:01
08-15-2025
Channel:      1
Name:        Name: 40
ACCUM. WEIGHT: 2590 lb
ACCUM. COUNT: 2
ACCUM. AVERAGE:      1295 lb
```

Super ↓ Ld-Unld → Accum

1. Press and hold **HOLD MENU** ...
Pass is briefly displayed before the text input prompt
2. Enter the Supervisor Menu Password (1793) and press **↵** ...
Super is now displayed
3. Press **▼** ...
Ld-Unld is now displayed
4. Press **▶** ...
AccuM is now displayed.

On/Off

Accumulation is turned off by default. To turn it on, follow the steps below.

5. Press **▼** ...
ON/OFF is now displayed.
6. Press **▼** ...
OFF is now displayed.
7. Use **◀** and **▶** to cycle through the print options (**On** and **Off**)...
8. When **ON** is displayed, press **↵** ...
Accumulation is now activated, and **ON/OFF** is now displayed.

Auto Minimum

9. Press **▶** ...
AutoMin is now displayed.
10. Press **▼** ...
Enter the Minimum Weight.
11. Press **↵** ...

TotENbl

Total Enable: Total Enable is turned on by default. To turn it off follow the steps below.

12. Press **▶** ...
TotENbl is now displayed.
13. Press **▼** ...
ON is now displayed.
14. Use **◀** and **▶** to cycle through the print options (**On** and **Off**)...
15. When **OFF** is displayed, press **↵** ...
Total Enable is now deactivated, and **TotENbl** is now displayed.

Total Format

16. Press **▶** ...
ToT FMT is now displayed.
17. Press **▼** ...
21 (system default) is displayed. Enter the desired Print Format Number.
18. Press **↵** ...
ToT FMT is now displayed.

Clear Total

Clear Total is turned off by default. To turn it on, follow the steps below.

19. Press **▶** ...
clr TOT is now displayed.
20. Press **▼** ...
OFF is now displayed.
21. Use **◀** and **▶** to cycle through the print options (**On** and **Off**)...
22. When **ON** is displayed, press **↵** ...
Clear Total is now activated, and **clr TOT** is now displayed.

Print

Print: Port 1, Port 2, and USB (default is to print to both a file and to an external printer or PC when connected. Plug in USB to retrieve file or to have file print directly to USB.)

23. Press **▶** ...
PriNt is now displayed.
24. Press **▼** ...
Port 1 is now displayed.
25. Use **◀** and **▶** to cycle through the print options (**Port 1**, **Port 2**, and **USb**)...
26. Press **↵** to make a selection...
PriNt is now displayed.

Reset

27. Press **▶** ...
RESET is now displayed.
28. Press **▼** ...
No is now displayed.
29. Press **▶** ...
yES is now displayed
30. Press **↵** to initiate the Reset...

5.7.2 Auto Accumulation Operation

Once the Auto Accum Min WT has been met, it will capture, print, and add to the current memory channel if Totals are enabled.

1. To reprint last Accum Ticket, press the **PRINT** key.
2. To print a Total Report, press and hold the **PRINT** key.
3. To subtract the last weighment from the Accumulation Total, press and hold the **M+/RM** key.

5.8 AutoLoc

AutoLoc is specifically designed for use in weighing livestock. Once the indicator has determined the animal's weight, the indicator automatically locks on that weight, and the weight reading will not change as long as the animal is on the scale. This makes the weight easy to record since the numbers do not rapidly change as the animal moves around on the scale.

5.8.1 AutoLoc Setup

Super ↓ Ld-Unld → Accum → AutoLoc

AutoLoc: AutoLoc allows the 660 to be used for weighing and recording an animal's weight automatically on an animal livestock scale. There are two modes, Standard and Advanced.

1. Press and hold **HOLD MENU** ...
Pass is briefly displayed before the text input prompt
2. Enter the Supervisor Menu Password (1793) and press **↵** ...
Super is now displayed
3. Press **▼** ...
Ld-Unld is now displayed
4. Press **▶** ...
AccuM is now displayed.
5. Press **▶** ...
AutoLoc is now displayed.

AutoLoc Mode

6. Press **▼** ...
ALCMode is now displayed
7. Press **▼** ...
disAbIE is now displayed
8. Use **◀** and **▶** to cycle through the print options (**Disable**, **Standard**, or **Advanced**)...
Disable turns off the AutoLoc function.
Standard allows the indicator to do Standard AutoLoc functions.
Advanced allows the indicator to do Advanced AutoLoc functions.

9. Press **↵** to make a selection...
ALCMode is now displayed

AutoLoc Min

10. Press **▶** ...
ALC MiN is now displayed.
11. Enter the Minimum Weight for the AutoLoc to lock onto a stable weight
12. Press **↵** ...
ALC MiN

AutoLoc Control

Enter Percent Weight Change

13. Press **▶** ...
ALCRTOL is now displayed.
14. Enter the desired weight percentage for AutoLoc Filter to restart after locking onto a stable weight.
15. Press **↵** ...
ALCRTOL is now displayed.

5.8.2 AutoLoc Operation

Standard Mode

1. Turn the indicator on, press the **G/N** key to access gross mode
2. Press the **ZERO** key.
3. Move the animal onto the scale.
4. WWWW is shown, the AUTO annunciator turns on, and the display turns red, and the display shows the animals AutoLocked weight.
5. If auto-accumulate is on, once the weight is locked-on, the 660 will automatically accumulate to the last selected memory channel.
6. The weight stays locked until the weight on the scale drops by the programmed release tolerance. (Example: weighing a 2000 lb animal with a 25% release tolerance, means the lock will release when weight drops below 1500 lb).
7. If the animal is released and the weight falls below the tolerance it may be possible to lock on another weighment. We recommend putting in a high release tolerance like 75% to ensure reliable operation.
8. To prevent an inadvertent AutoLoc (Ex: someone leans/steps on the scale), we recommend setting the **ALC MiN** parameter to 50% of the expected average animal weight.
9. Remove the animal from the scale. Scale returns to live weighing mode
10. Repeat steps 2 and 3 for every animal.
11. When a false locked weight occurs, either: To just unlock the displayed weight and reweigh the animal, press the **HOLD/MENU** key to unlock the indicator to recheck the animal's weight

OR

To remove an accumulated weight from an accumulated value press and hold **M+/RM** key to recheck the animal's weight and to remove last weight from the memory channel. This will also delete from the accumulators the last locked-on weight and replace it with the new locked-on weight.

Advanced Mode

The following describes how the 660 can be used for weighing and recording animal's weight automatically on a single animal livestock scale using the advanced AutoLoc mode. The indicator must be set up for AutoLoc and set for advanced (AdvANcE) mode. The 660 will lock on an animal's weight and stay locked even after the animal is off the scale. A new AutoLoc weight will only be retriggered upon placing the next animal on the scale.

1. Turn the indicator on, press the **G/N** key to access gross mode
2. Press the **ZERO** key.
3. Move the animal onto the scale.
4. WWWW is shown, the AUTO annunciator turns on, and the display turns red, and the display shows the animals AutoLocked weight.
5. If auto-accumulate is on, once the weight is locked-on, the Model 660 will automatically accumulate to the last selected memory channel.
6. To prevent an inadvertent AutoLoc (Ex: someone leans/steps on the scale), we recommend setting the **ALC MiN** parameter to 50% of the expected average animal weight.
7. Remove the animal from the scale. When in Advanced Mode the AutoLoc reading will stay on the display until another animal walks onto the scale. This was designed to help with record keeping.
8. Repeat steps 2 and 3 for all animals.
9. When a false locked weight occurs, either: To just unlock the displayed weight and reweigh the animal, press the **HOLD/MENU** key to unlock the indicator to recheck the animal's weight

OR

To remove an accumulated weight from an accumulated value press and hold **M+/RM** key to recheck the animal's weight and to remove last weight from the memory channel. This will also delete from the accumulators the last locked-on weight and replace it with the new locked-on weight.

6 Remote Assist Mobile App Walkthrough

This section covers the free Avery Weigh-Tronix Remote Assist mobile app that pairs with any 660 via Bluetooth. Remote Assist provides users with additional features to make the indicator more flexible. Using the Remote Assist app can: remotely view live weights, use some of the indicator keys, view and change a wide range of app defined weight data fields, change UDF (User Defined Fields) printable text fields that can be used on a print ticket or label, and use operator prompts to aid in using the 660. The Remote Assist mobile app is available in Android, IOS, and Windows formats and can be downloaded using the QR code below or directly from the Google Play or Apple App Store.



Note: it is recommended to restart your indicator and the application after changing anything under the configuration menu.

6.1 Remote Assist Mobile App Breakdown

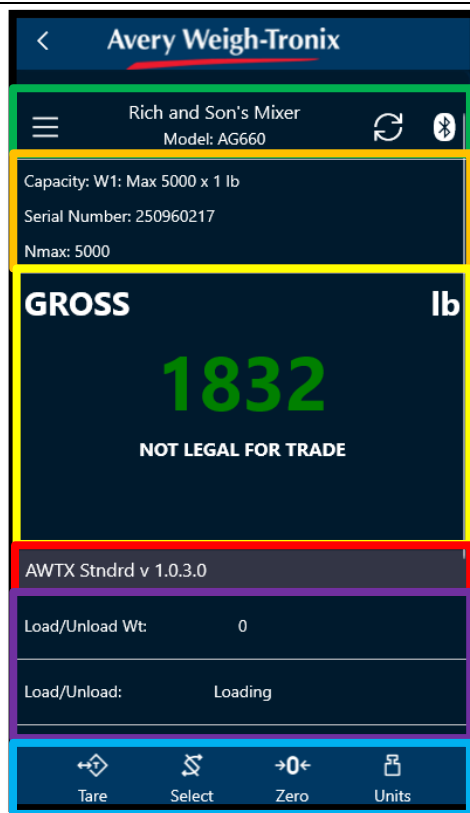

Menu button, Scale data, Refresh button, and Bluetooth icon. Device Settings, Name, Model, Connection Type – (Firmware Driven)
Scale Device Info: Capacity, Serial Number, Etc. – (Firmware Driven)
Active Value, Weight, and Units – (Firmware Driven)
User Prompt - (App Driven)
UDF (User Defined Fields) + Custom App Buttons – (App Driven) <ul style="list-style-type: none"> Driven using LUA Variables Define which values you want displayed and their order. Variable description, value, and read/write status is show. Define custom buttons and colors.
Device Keys/Remote Keys – (Firmware Driven)

6.2 Downloading the Remote Assist Application

Download the Remote Assist app to any smartphone or tablet from either the Google Play Store or the Apple App Store by using the QR Code below.

Google Play Store: [AWTX Remote Assist - Apps on Google Play](#)

Apple App Store: [AWTX Remote Assist on the App Store](#)

OR

Search “AWTX Remote Assist” in either App Store and tap on the Remote Assist App Icon.

Once downloaded, tap the R-Assist icon to launch the application.

6.3 Connecting a Scale

1. Tap the R-Assist application icon.
2. Tap “Add Bluetooth Device”

Choose Start scanning: select the Serial Number that corresponds to the desired 660 Indicator.

OR

Use QR code on the back of the indicator be sure to scan the Bluetooth Connection sticker on the back right hand side of the indicator.



3. Name the device, while being sure to maintain an easy to remember naming convention.



Note: We recommend that users maintain a reliable naming convention for your units. For example, if there are three farm scales (Named: Grain Cart, Mixer, and Animal Scale), so when connecting to an indicator through Remote Assist you will see Grain Cart, Mixer, and Animal Scale.

4. Tap the OK button and the mobile device is connected to the 660 Indicator.

6.4 Mobile App Screen Navigation

To navigate between the menus of the Remote Assist application use the Navigation Popup menu.

To access the Navigation Popup menu, tap the Navigation Button on the upper left-hand side of the home screen.



Note: The Navigation Button will be in the same location on every page of the Remote Assist Mobile App. Subject to the app that is running in the 660, some fields, like reports, may not be available in the app.

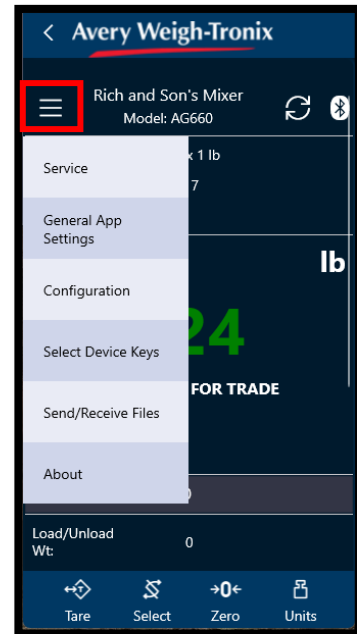

6.5 Using the Active Scale Fields from the Remote Assist Mobile App

Display colors are dependent on the active application/function. For example, if AutoLoc is enabled and a weight has been locked on, display numbers will turn red. When the weight is unlocked the display turns back to green.

Each of the scale fields that are enabled in the mobile app are used to provide clear visuals of the process parameters.

Adjusting any fields with a pencil icon can be done remotely from the mobile app. To do this simply:

1. Tap on the pencil icon area of the Remote Assist mobile app screen.
2. The popup window is now displayed for that scale field.
3. Type in your new value or description and tap the "Save" button in the middle of the popup window.
4. The new value will be saved in the indicator and the Scale Field box in the Remote Assist mobile app screen will show the changed data.



Note: If you enter the Supervisor menu on the 660 Indicator when you return to live weight mode, it is recommended that you press the "Reconnect" key on the top right of the Remote Assist app screen. This ensures all new parameters are loaded correctly in the mobile app.



Note: Digit colors in the Remote Assist app match those of the backlight settings in the 660.

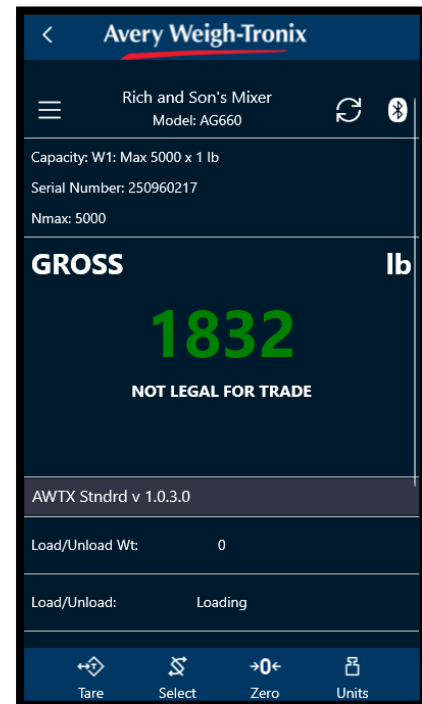

6.6 Text Prompt Messaging

In some applications, the text prompt window area on the Remote Assist app screen is used to provide additional operator instructions or acknowledgements when certain steps in the process have been reached.

These messages are built into the 660 Indicator application running in the indicator.

6.7 Mobile App Settings

Under the Application Settings Menu users have access to the following fields:

- Include date on stored transactions
- Include time on stored transactions
- Auto Reconnect
- CSV Export Formats
- Select Language
- Report Title

Auto Reconnect automatically connects the mobile device to a previously paired indicator. If Auto Reconnect is active, it may be difficult for another mobile Bluetooth device to gain connection.



Note: The Application Setting Menu also contains links to Avery Weigh-Tronix Privacy Policy and End User License Agreement.

To save changes to the Remote Assist App Settings, make the desired changes and then tap the “OK” button on the lower left-hand corner of the screen shown below.

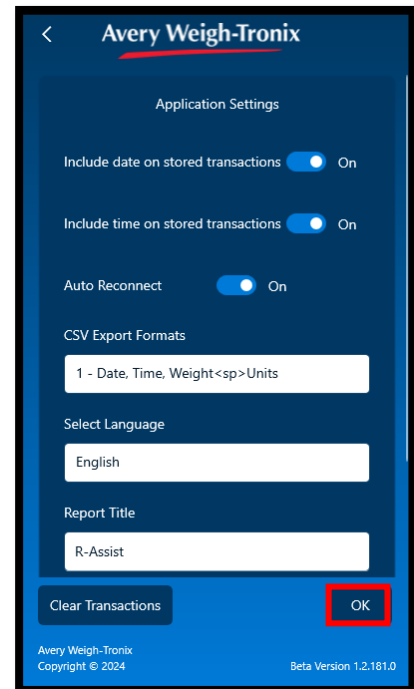

6.8 Configuration

The Configuration page allows you to access some of the 660's "Supervisor Menu" options from within the Remote Assist App.

- Set Division
- Select Unit of Measure
- Activate AutoLoc
- Activate Auto Accumulation
- Set Print Formats.

To save any changes made to the Configuration page tap the **OK** button.

Avery Weigh-Tronix

Division
1

Units
LB

Auto Lock Off

Auto Accum Off

Print Format
GTN w/ TD (STD)

OK

6.9 Send/Receive Files

The Send/Receive File page allows users to Send Archive Files and Error Files as well and upload Calibration Files to the indicator through the Remote Assist App.

Avery Weigh-Tronix

Send/Receive Files

Calibration File

Archive File

Error File

Cancel

6.10 Select Device Keys

Under the Select Device Key page, users can select what indicator keys and functions that appear on the Remote Assist home screen as well as their order.

Tap the arrow symbols to change the order (from left to right) the buttons will be in on the Home Screen.

Tap the plus button next to any of the keys under the Available Device Keys to add them to the Home Screen buttons.

Tap the minus symbol next to any of the buttons under the Selected Device Keys to remove them from the Home Screen.

The available keys are:

- Tare (default)
- Select (default)
- Zero (default)
- Units (default)
- Print
- Export (exports the stored live weights captured to a CSV or Excel file)
- Store (saves live weight readings from the indicator inside the Remote Assist Mobile App)

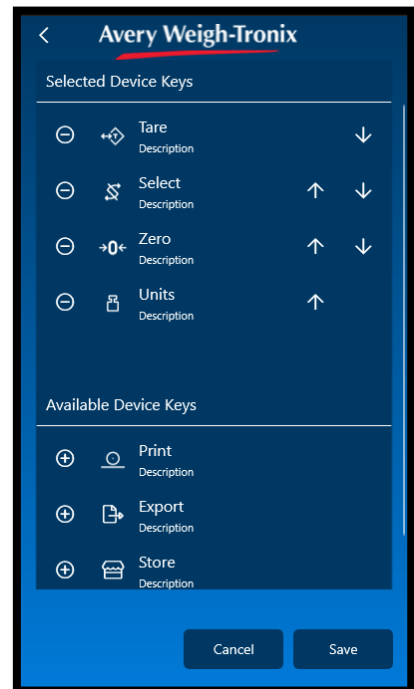

Note: Some of the optional keys in the Remote Assist App may not work with the 660. AWTX Mobile App works with a broad line of AWTX indicators.

Tap the arrow symbols to change the order (from left to right) the buttons will be in on the Home Screen.

Tap the plus button next to any of the keys under the Available Device Keys to add them to the Home Screen buttons.

Tap the minus symbol next to any of the buttons under the Selected Device Keys to remove them from the Home Screen.

6.11 About Page

The About Page gives users critical information about the app and the currently paired indicator.

- Device Model
- Device Serial Number
- Scale 1
- Unit
- Capacity
- Divisions
- Firmware Version
- Bootloader Version
- Application Name (Indicator)
- Application Version (Indicator)

7 User Menu

The **USER** level contains the User, About, and Audit menus as shown below.

- To access the **USER** level, from normal weighing mode, press and hold the **HOLD MENU** key.
- Enter password 111 and press the **←** key.



Note: Many of menus below are not used in AG applications and are specific to legal for trade applications.

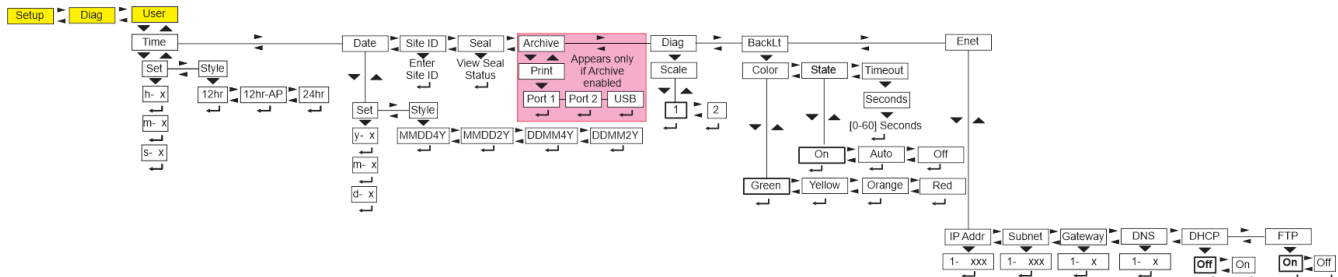

7.1 Time

User ↓ Time

Time: This lets users set the clock and choose the style of the time display 12 hr, 12 hr a.m./p.m., or 24 hr. The Time can be used in print formats.

- Access the User Menu and Press **▼** ...

tiME is now displayed. Use this to set the time and clock style.

Set time

Time ↓ Set

Set: Enter in the hour, minute, and second.

- From **tiME**, press **▼** ...
SEt is now displayed
- Press **▼** ...
h- x is now displayed, with the **x** flashing. This is a numeric entry screen for the hour value.
- Enter the hour of the day using military (24 hr) time and press **←** to accept...
M- x is now displayed, with the **x** flashing. This is a numeric entry screen for the minute value.
- Enter the minute value and press **←** to accept...
S- x is now displayed, with the **x** flashing. This is a numeric entry screen for the second value.

- Enter the seconds value and press **←** to accept...
SEt is now displayed.

Style

Time ↓ Set → Style

Style: Choose the style of the time display (12 hr, 12 hr a.m./p.m., or 24 hr military)

- From **SEt** press **▶** ...
StYLE is now displayed.
- Press **▼** ...
12hr is now displayed.
- Press **◀** or **▶** to scroll through the choices. Press **←** when your choice is now displayed ...
StYLE is now displayed.
- Press **▲** ...
tiME is now displayed.

7.2 Date

User ↓ Time → Date

Date: This allows users set the year, month, day, and the style of the displayed date. The Date can be used in print formats.

1. From **tiME**, press **▶** ...
dAtE is now displayed.

Set date

Date ↓ Set

Set: Enter in the date's year, month, and day.

2. From **dAtE** press **▼** ...
SEt is now displayed.
3. Press **▼** ...
yy- x is now displayed, with the **x** flashing. This is a numeric entry screen for the year value.
4. Enter the year and press **↵** to accept ...
MM- x is now displayed, with the **x** flashing. This is a numeric entry screen for the month.
5. Enter the month value and press **↵** to accept ...
dd- x is now displayed, with the **x** flashing. This is a numeric entry screen for the day value.
6. Enter the day value and press **↵** to accept ...
SEt is now displayed.

Style

Date ↓ Set → Style

Style: Choose the style for how the date display (MMDD2Y, MMDD4Y, DDMM2Y, and DDMM4Y)

7. Press **▶** ...
StYLE is now displayed.
8. Press **▼** ...
MMDD4Y is now displayed.
9. Press **◀** or **▶** to scroll through the choices. The choices are **MMDD2Y**, **MMDD4Y**, **DDMM2Y**, and **DDMM4Y**.
10. Press **↵** when your choice is now displayed ...
StYLE is now displayed.
11. Press **▲** ...
dAtE is now displayed.

7.3 Site ID

User ↓ Time → Date → Site ID

Site ID: This allows users to enter a Site ID. Use the alphanumeric keys to enter a Site ID (maximum 7 digits). Site ID can be used in a print format.

1. From **dAtE**, press **▶** item...
SitE id is now displayed.
2. Press **▼** ...
A string entry screen is now displayed.
3. Enter the site ID number on the numeric keypad and press **↵** to accept ...
SitEid is now displayed.

7.4 Seal







User ↓ Time → Date → Site ID → Seal

The 660 does not have seal jumper support. The reason the option may appear to users in some menus is because the software used on the 660 is used on other Avery Weigh-Tronix indicators that do have seal jumper support.

7.5 Diagnostics

User ↓ Time → Date → Site ID → Seal → Diagnostics

Diagnostics: this allows users to view and change basic diagnostics settings for the indicator and any connected scale bases.

1. From **SEAI**, press  item...
diAg is now displayed.
2. Press  ...
ScAIE is not displayed.
3. Press  ...
Scale # is now displayed.
4. Press  ...
The Version Number is now displayed
5. Press  ...
ScAIE is not displayed.
6. Press  ...
diAg is now displayed.

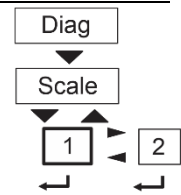

7.6 Backlight

User ↓ Time → Date → Site ID → Seal → Diagnostics → Backlight

BackLt: This allows users to set the primary back light color for the indicator. Some of the Indicator apps will override the primary back light color. In these apps the back light control setting can be modified from within the Supervisor Menu.

Color: This allows the user to set the color of the primary backlight (Green, Yellow, Orange, or Red). The “None” option turns off the backlight putting the indicator in Outdoor mode.

State: This allows the user to turn the backlight on, off, or to automatically trigger when the indicator is interacted with.

Timeout: This allows the user to set the length of time before the backlight turns off.

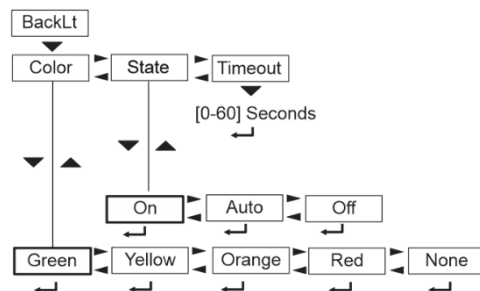

Adjust the backlight brightness and contrast by holding the **HOLD MENU** (brightness) or **M+ RM** (contrast) key and use ▲ and ▼ to adjust the settings. The brightness and contrast are saved automatically and will be applied after a reboot.

1. From **diAg**, press ► ...
BackLt is now displayed.
2. Press ▼ ...
Color is now displayed. Press ▼ again and use ◀ or ▶ to cycle through the available backlight colors (**Green, Yellow, Orange, and Red**).
3. Press ↵ to choose the displayed color option...
Color is now displayed.
4. From **Color** press ► ...
State is now displayed. Press ▼ again and use ◀ or ▶ to cycle through the available options (**On, Auto, and Off**).
5. From **State** press ► ...
Timeout is now displayed. Press ▼ again to enter in the timeout limit [between 0-60 seconds].
6. Press ↵ to accept the displayed value...
TiMout is now displayed.
7. Press ▲ ...
diSPIAy is now displayed.

7.7 Ethernet

The 660 does not have Ethernet support. The reason the option may appear to users in some menus is because the software used on the 660 is used on other Avery Weigh-Tronix indicators that do have Ethernet connectivity.

8 Supervisor Menu

The Supervisor Menus allow users to setup and change the functions of any of the configurable indicator applications that come with the 660.

Wherever there is an option to print information in the any of the Supervisor's Menu, the information will print out of Port 1, Port 2, or to USB, whichever is configured.

Access the Supervisor Menu using the password **1793**. Please note that the Supervisor Menu changes based on the active application running and that the menus are always explained sequentially. Users can navigate to the area of the menu that needs to be changed by using the navigation keys.

1. Press and hold **HOLD MENU** ...
Pass is briefly displayed before the text input prompt
2. Enter the Supervisor Menu Password (1793) and press **←** ...
Super is now displayed.

8.1 General Supervisor Menu

Use the 1793 password to access the Supervisor Menu.

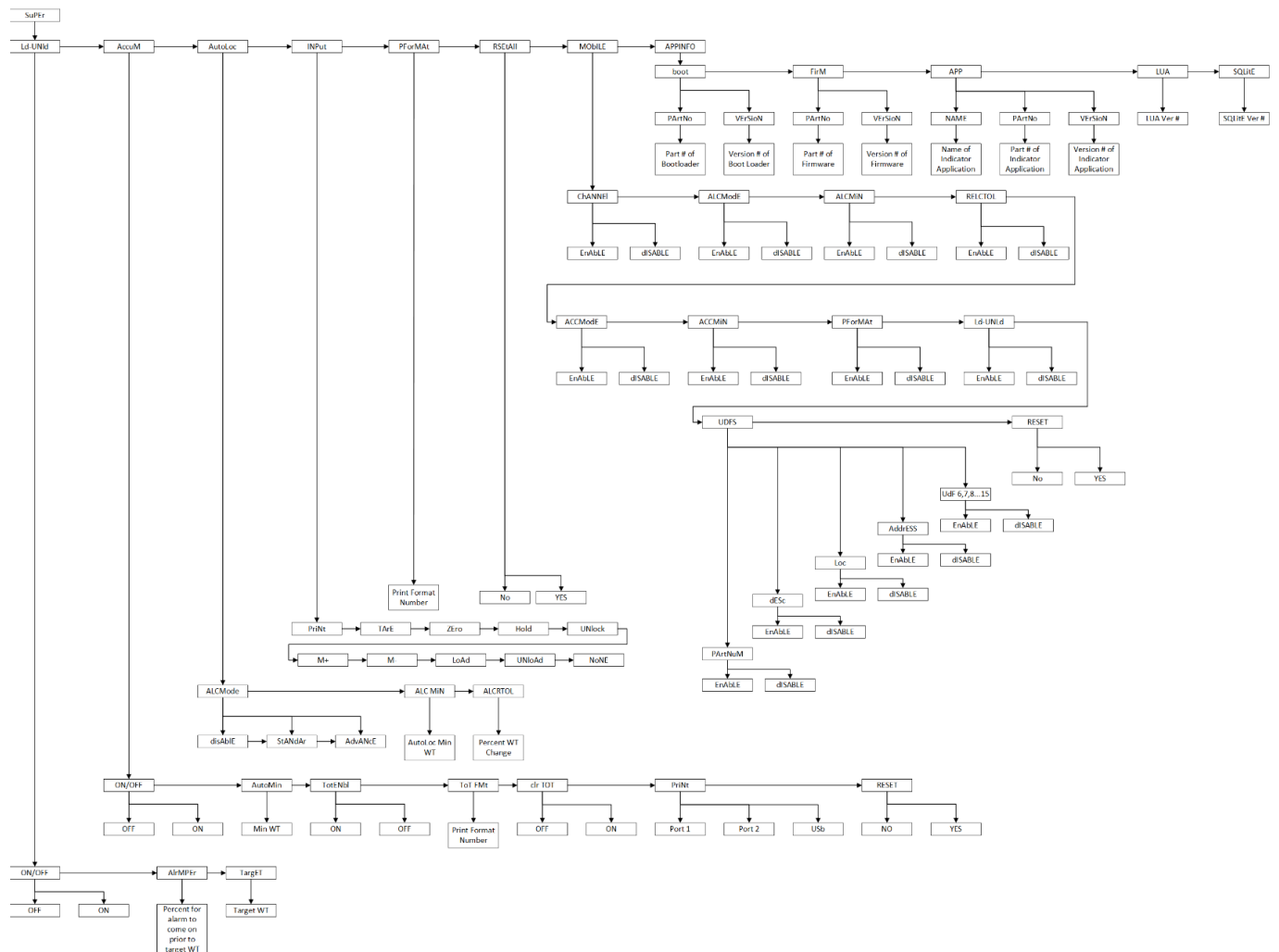



Note: Wherever there is an option to print information, the information will print out of Port 1, Port 2, or to USB, whichever is configured.



Note: The menus are always explained in a sequential manner to cover all information in a logical fashion. You will probably never access all the menu items in this manner. You can navigate to the area of the menu that needs to be changed by using the navigation key chart shown with the menu.

Follow these steps to set the items in the Supervisor menu.

8.2 Load Unload

Super ↓ Ld-Unld

Load Unload: Setting a target

1. Press and hold **HOLD MENU** ...
Pass is briefly displayed before the text input prompt
2. Enter the Supervisor Menu Password (1793) and press **↵** ...
SUPER is now displayed
3. Press **▼** ...
Ld-UNld is now displayed

On/Off

Load Unload is turned off by default. To turn it on, follow the steps below.

4. Press **▼** ...
ON/OFF is now displayed.
5. Press **▼** ...
OFF is now displayed.
6. Use **◀** and **▶** to cycle through the print options (**On** and **Off**)...
7. When **ON** is displayed, press **↵** ...
 Load Unload is now activated, and **ON/OFF** is now displayed.

Alarm Percent

8. Press **▶** ...
AIRMPER is now displayed.
9. Press **▼** ...
10 (system default) is now displayed.
10. Enter the desired percentage required to trigger an alarm.
11. Press **↵** ...
AIRMPER is now displayed.

Target Weight

12. Press **▶** ...
TARGET is now displayed.
13. Press **▼** ...
100 (system default) is now displayed.
14. Enter the desired Target Weight
 press **↵** ...
TARGET is now displayed.
15. Press **▲** repeatedly until **SAVE No** is displayed.
16. Press **▶** to scroll through the choices: **SAVE No**, **SAVEYES**, and **CANCEL**.
 Press **↵** to accept the displayed choice.
 Select **SAVE No** or **SAVEYES** to have the indicator exit the current menu and returns to normal weighing mode.
 OR
 Select **CANCEL** for the indicator to remain in the current menu.

8.3 Accumulation

Super ↓ Ld-Unld → Accum

1. Press and hold **HOLD MENU** ...
Pass is briefly displayed before the text input prompt
2. Enter the Supervisor Menu Password (1793) and press **↵** ...
Super is now displayed
3. Press **▼** ...
Ld-UNId is now displayed
4. Press **▶** ...
AccuM is now displayed.

On/Off

Accumulation is turned off by default. To turn it on, follow the steps below.

5. Press **▼** ...
ON/OFF is now displayed.
6. Press **▼** ...
OFF is now displayed.
7. Use **◀** and **▶** to cycle through the print options (**On** and **Off**)...
8. When **ON** is displayed, press **↵** ...
Accumulation is now activated, and **ON/OFF** is now displayed.

Auto Minimum

9. Press **▶** ...
AutoMin is now displayed.
10. Press **▼** ...
100 (system default) is now displayed.
11. Enter the Minimum Weight and press **↵** ...

TotENbl

Total Enable: Total Enable is turned on by default. To turn it off follow the steps below.

12. Press **▶** ...
TotENbl is now displayed.
13. Press **▼** ...
ON is now displayed.
14. Use **◀** and **▶** to cycle through the print options (**On** and **Off**)...
15. When **OFF** is displayed, press **↵** ...
Total Enable is now deactivated and **TotENbl** is now displayed.

Total Format

16. Press **▶** ...
ToT FMT is now displayed.
17. Press **▼** ...
21 (system default) is now displayed
18. Enter the desired Print Format Number.
19. Press **↵** ...
ToT FMT is now displayed.

Clear Total

Clear Total is turned off by default. To turn it on, follow the steps below.

20. Press **▶** ...
clr TOT is now displayed.
21. Press **▼** ...
OFF is now displayed.
22. Use **◀** and **▶** to cycle through the print options (**On** and **Off**)...
23. When **ON** is displayed, press **↵** ...
Clear Total is now activated, and **clr TOT** is now displayed.

Print

Print: Port 1, Port 2, and USD

24. Press **▶** ...
PriNt is now displayed.
25. Press **▼** ...
Port 1 is now displayed.
26. Use **◀** and **▶** to cycle through the print options (**Port 1**, **Port 2**, and **USb...**)
27. Press **↵** to make a selection...
PriNt is now displayed.

Reset

28. Press **▶** ...
RESET is now displayed.
29. Press **▼** ...
No is now displayed.
30. Press **▶** ...
yES is now displayed
31. Press **↵** to initiate the Reset...
32. Press **▲** repeatedly until **SAVe No** is displayed.
33. Press **▶** to scroll through the choices: **SAVe No**, **SAVeYES**, and **CANcEI**.
Press **↵** to accept the displayed choice.

Select **SAVe No** or **SAVeYES** to have the indicator exit the current menu and returns to normal weighing mode.

OR

Select **CANcEI** for the indicator to remain in the current menu.

8.4 AutoLoc

Super ↓ Ld-Unld → Accum → AutoLoc

AutoLoc: Auto Lock allows the 660 to be used for weighing and recording an animal's weight automatically on a single animal livestock scale. There are two modes, Standard and Advanced. The difference between Standard and Advanced AutoLoc is that Advanced allows the 660 to lock onto an animal's weight and stay locked even after the animal is off the scale. A new AutoLoc weight will only be retriggered upon the next animal walking onto the scale.

1. Press and hold **HOLD MENU** ...
Pass is briefly displayed before the text input prompt
2. Enter the Supervisor Menu Password (1793) and press **↵** ...
Super is now displayed
3. Press **▼** ...
Ld-Unld is now displayed
4. Press **▶** ...
AccuM is now displayed.
5. Press **▶** ...
AutoLoc is now displayed.

AutoLoc Mode

6. Press **▼** ...
ALCMode is now displayed
7. Press **▼** ...
diSAbIE is now displayed
8. Use **◀** and **▶** to cycle through the print options (**Disable**, **Standard**, or **Advanced**)...
Disable turns off the AutoLoc function.
Standard allows the indicator to do Standard AutoLoc functions.
Advanced allows the indicator to do Advanced AutoLoc functions.
9. Press **↵** to make a selection...
ALCMode is now displayed

AutoLoc Min

10. Press **▶** ...
ALC MiN is now displayed.
11. Press **▼** ...
100 (system default) is now displayed.
12. Enter the desired minimum weight and press **↵** ...
ALC MiN

AutoLoc Control

Enter Percent Weight Change

13. Press **▶** ...
ALCRTOL is now displayed.
14. Press **▼** ...
15 (system default) is now displayed.
15. Enter the desired weight percentage and press **↵** ...
ALCRTOL is now displayed.
16. Press **▲** repeatedly until **SAVe No** is displayed.
17. Press **▶** to scroll through the choices: **SAVe No**, **SAvEYES**, and **CANcEI**.
Press **↵** to accept the displayed choice.

Select **SAVe No** or **SAvEYES** to have the indicator exit the current menu and returns to normal weighing mode.

OR

Select **CANcEI** for the indicator to remain in the current menu.

8.5 Input

Super ↓ Ld-Unld → Accum → AutoLoc → Input

Input: Peripheral devices connected to 9 point connector

1. Press and hold **HOLD MENU** ...
Pass is briefly displayed before the text input prompt
2. Enter the Supervisor Menu Password (1793) and press **←** ...
Super is now displayed
3. Press **▼** ...
Ld-Unld is now displayed
4. Press **▶** ...
AccuM is now displayed.
5. Press **▶** ...
AutoLoc is now displayed.
6. Press **▶** ...
INPut is now displayed.
7. Press **▶** to scroll through the available Input options:
 - Print
 - Tare
 - Zero
 - Hold
 - Unlock
 - M+ (Memory) Add Memory Channel
 - M- (Memory) Remove Added Memory Channel
 - Load
 - Unload
 - None
8. Press **←** to accept the displayed choice.
INPut is now displayed.
9. Press **▲** repeatedly until **SAVe No** is displayed.
10. Press **▶** to scroll through the choices: **SAVe No**, **SAvEYES**, and **CANcEI**. Press **←** to accept the displayed choice.

Select **SAVe No** or **SAvEYES** to have the indicator exit the current menu and returns to normal weighing mode.

OR

Select **CANcEI** for the indicator to remain in the current menu.

8.6 Print Format

Super ↓ Ld-UnId → Accum → AutoLoc → Input → PFormat

Print Format: This controls the format of any ticket printed from the 660.

1. Press and hold **HOLD MENU** ...
Pass is briefly displayed before the text input prompt
2. Enter the Supervisor Menu Password (1793) and press **↵** ...
Super is now displayed
3. Press **▼** ...
Ld-UnId is now displayed
4. Press **▶** ...
AccuM is now displayed.
5. Press **▶** ...
AutoLoc is now displayed.
6. Press **▶** ...
INPut is now displayed.
7. Press **▶** ...
PForMAt is now displayed.
8. Press **▼** ...
3 (system default) is now displayed.
9. Enter the desired Print Format Number and press **↵** ...
The Print Format has now been updated and **PForMAt** is now displayed.
10. Press **▲** repeatedly until **SAVe No** is displayed.
11. Press **▶** to scroll through the choices: **SAVe No**, **SAvEYES**, and **CANcEI**. Press **↵** to accept the displayed choice.
Select **SAVe No** or **SAvEYES** to have the indicator exit the current menu and returns to normal weighing mode.

OR

Select **CANcEI** for the indicator to remain in the current menu.

8.7 Reset All

Super ↓ Ld-UnId → Accum → AutoLoc → Input → PFormat → RsetAll

Reset All: This allows users to reset all Supervisor Menu Settings to factory default settings.

1. Press and hold **HOLD MENU** ...
Pass is briefly displayed before the text input prompt
2. Enter the Supervisor Menu Password (1793) and press **↵** ...
Super is now displayed
3. Press **▼** ...
Ld-UnId is now displayed
4. Press **▶** ...
AccuM is now displayed.
5. Press **▶** ...
AutoLoc is now displayed.
6. Press **▶** ...
INPut is now displayed.
7. Press **▶** ...
PForMAt is now displayed.
8. Press **▶** ...
RSEtAll is now displayed.
9. Press **▼** ...
No is now displayed
10. Press **▶** ...
YES is now displayed.
11. Press **↵** ...
The 660's Supervisor Menu will now be reset its factory default settings and **RSEtAll** is now displayed.

8.8 Mobile

Super ↓ Ld-Unld → Accum → AutoLoc → Input PFormat → RsetAll → Mobile

Mobile: This controls what fields can be seen/used on the Remote Assist Mobile App. This section is split into two sections: Scale-Related fields and User Defined Fields (UDFs).

The Available Mobile Options are:

- Channel
- Autoloc Mode
- Autoloc Minimum
- RELCTOL
- Accumulation Mode
- Accumulation Minimum
- Print Format
- Ld-UNLd:
- User Defined Fields:
 - Part Number
 - Desc
 - Loc
 - Address
 - UDF 6-15
 - Reset

8.9 App Info

Super ↓ Ld-Unld → Accum → AutoLoc → Input → PFormat → RsetAll → Mobile → App Info

App Info: This allows users to view the Name, Part Number, and Version of the software running on the indicator.

The viewable fields are:

- Bootloader
- Firmware
- Application
- Lua
- SQLite

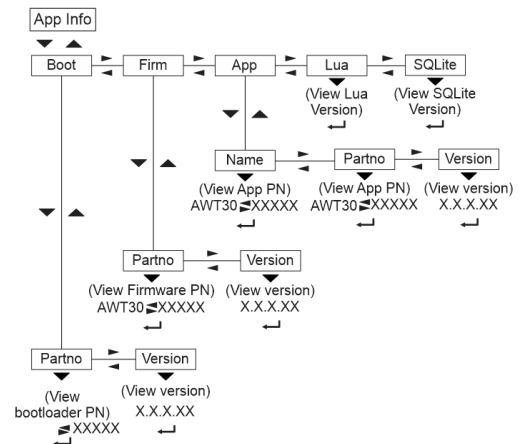

9.2 Diagnostics Menu

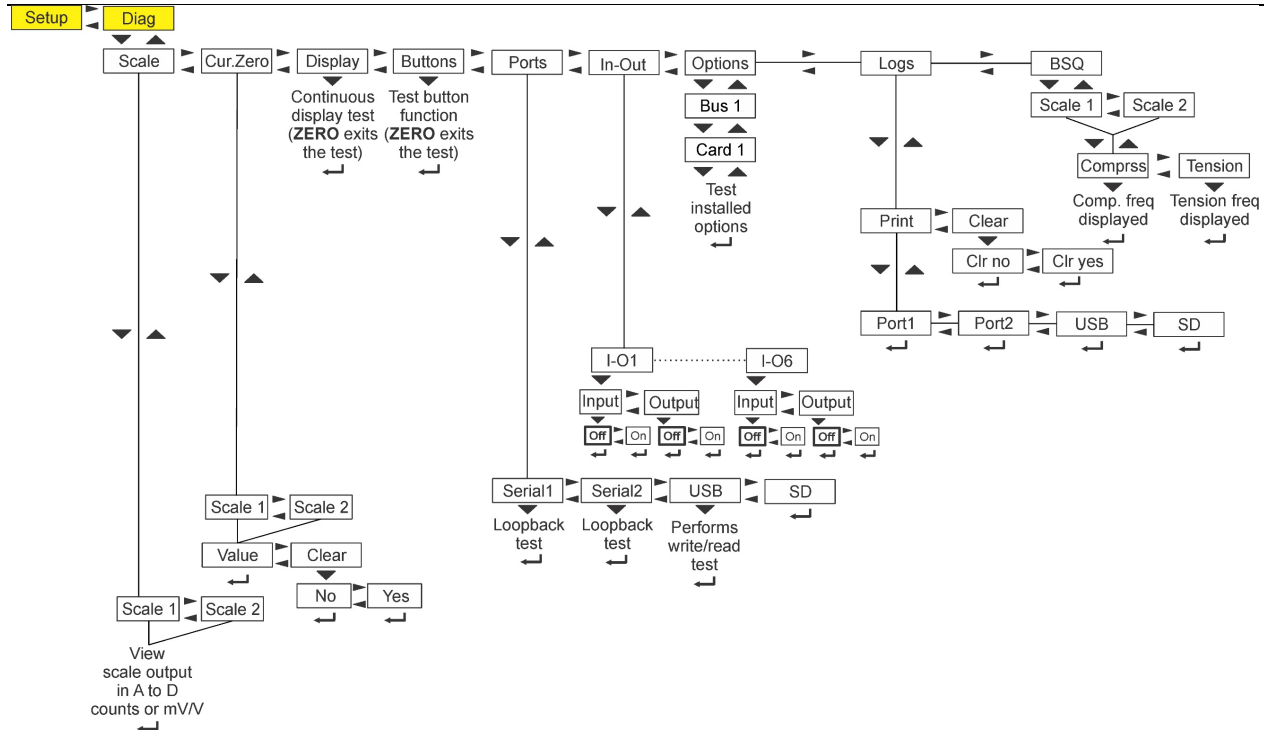

9.3 About Menu

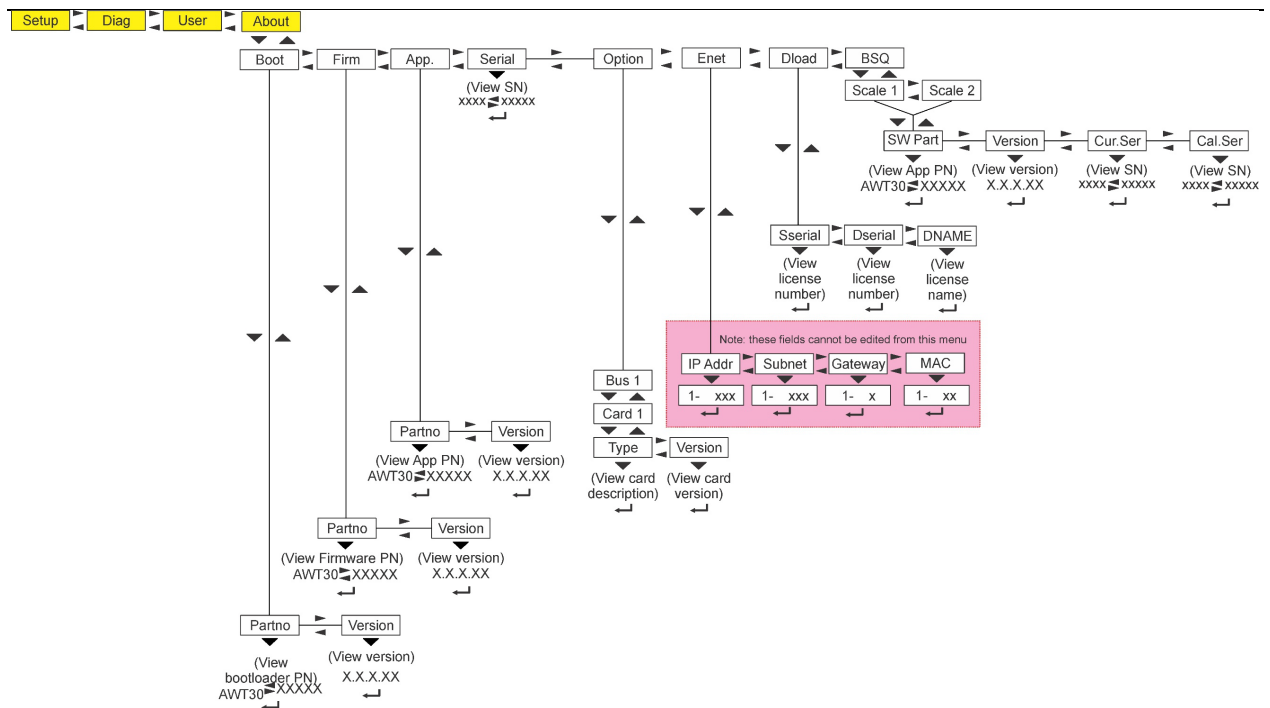

9.5 Aduit Menu

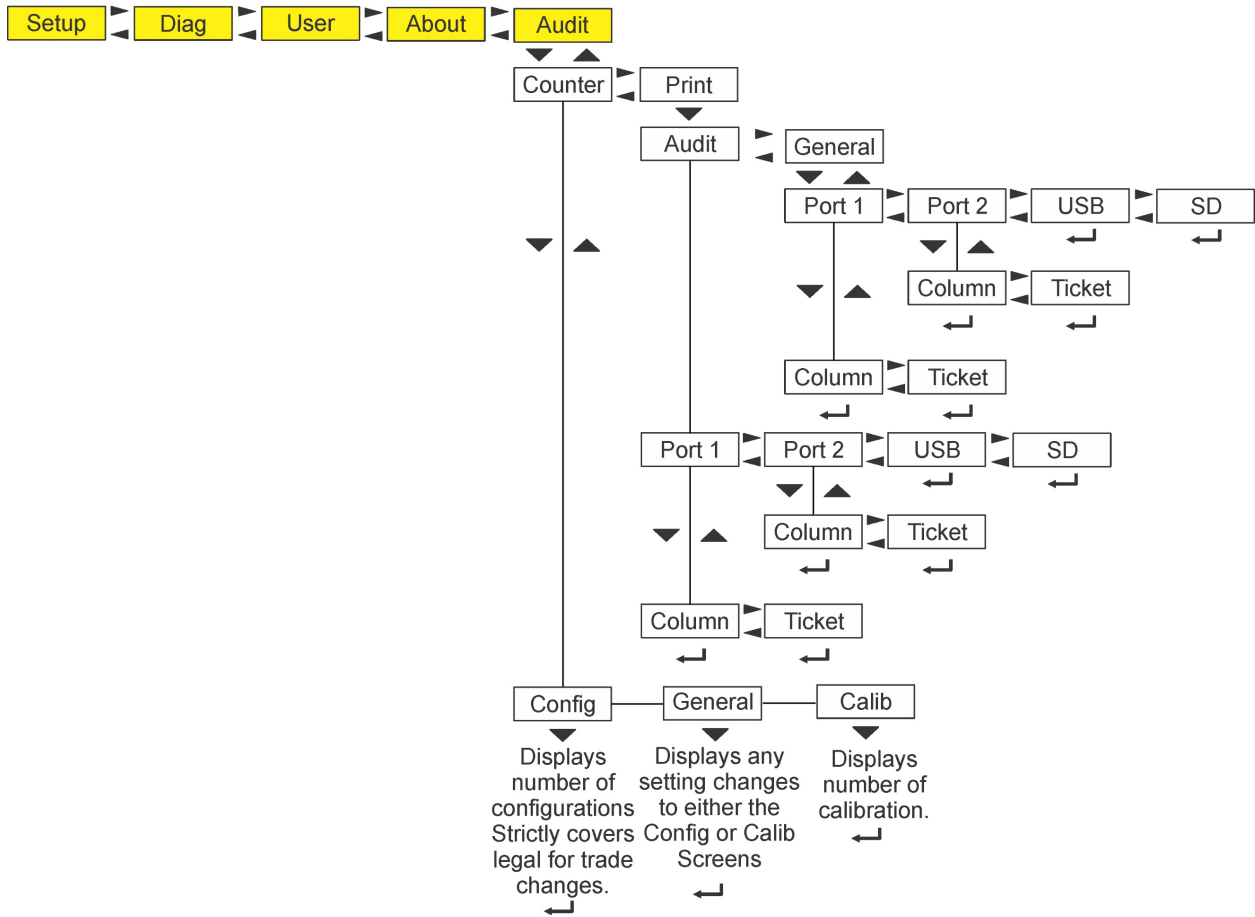

10 Default Print Formats

Print Format Number	Description	Example Ticket
1	GTN	Gross 1495 lb Tare 2455 lb Net -960 lb
2	G w/ TD	Gross 1495 lb 04:49:25 05-02-2025
3	GTN w/TD (Default)	Gross 1495 lb Tare 2455 lb Net -960 lb 04:51:10 05-02-2025
4	CSV-G	Gross 1495 lb
5	CSV-GTN	Gross 1495 lb Tare 2455 lb Net -960,lb
6	CSV-G w/TD	Gross 1495,lb 05:04:38,05-02-2025
7	CSV-GTN w/TD	Gross 1495,lb Tare 2455,lb Net -960,lb 05:06:25,05-02-2025

Avery Weigh-Tronix

Print Format Number	Description	Example Ticket
8	Displayed Wt.	1495 lb G
9	Displayed Wt. w/TD	1495 lb G 05:08:28 05-02-2025
10	G	Gross 1495 lb
21	Total Report Print Format	02:08:01 08-15-2025 Channel: 1 Name: Name: 40 ACCUM. WEIGHT: 2590 lb ACCUM. COUNT: 2 ACCUM. AVERAGE: 1295 lb

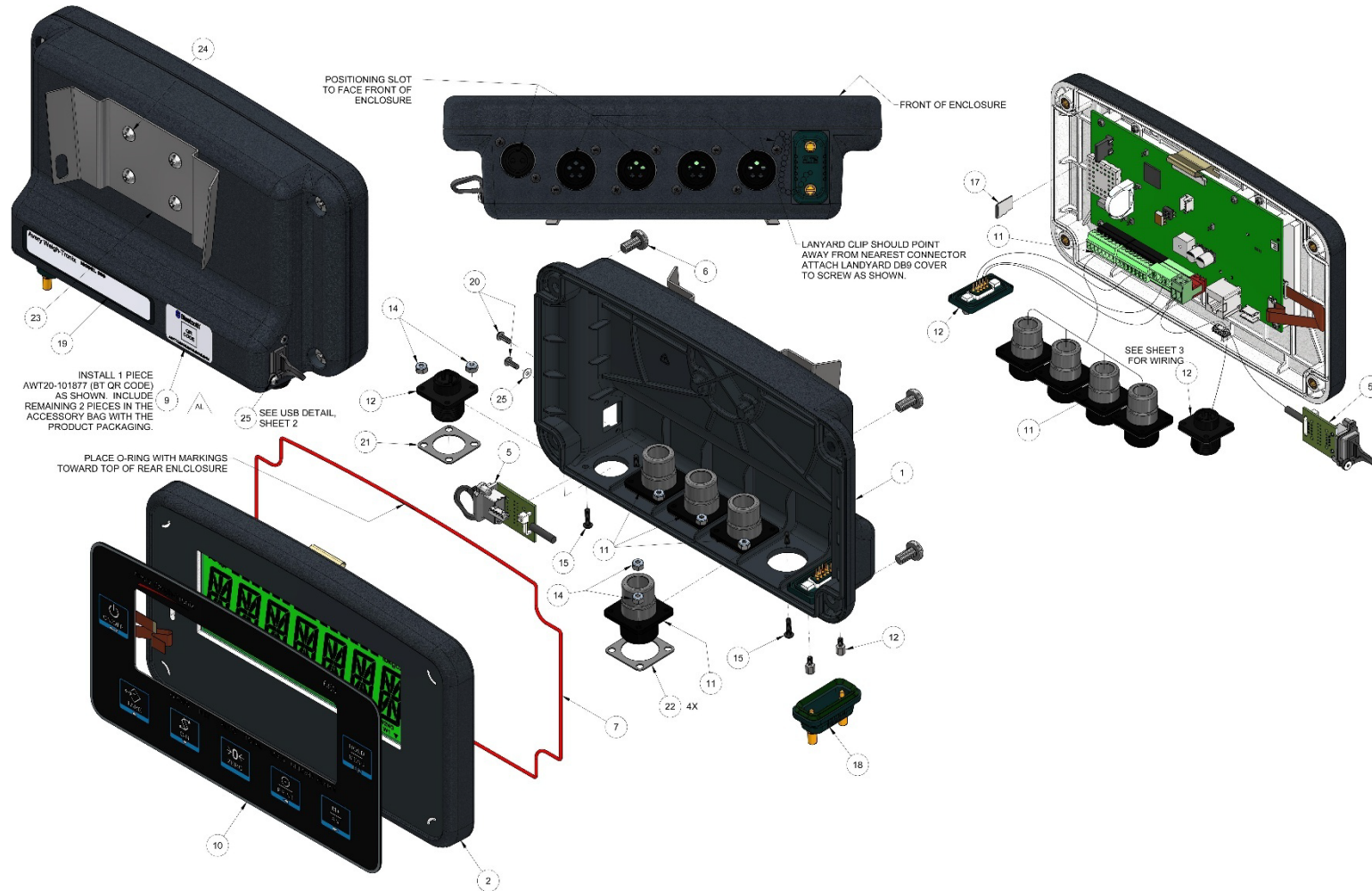

11 Technical Illustrations

11.1 660 Enclosure Assembly



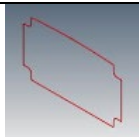

11.2 Parts Kit List

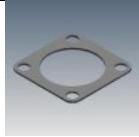
Kit Name: KIT, PCB, MAIN, 660			
Part Number: AWT05-101216			
Diagram	Item	Qty.	Description
		5	SCREW, MACH PH M3-0.5 X 6MM SST
		1	PCB ASSY, MODEL ZM22X/AG660
		5	SCREW, M3 X 6MM SELF TAP



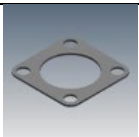

Kit Name: SERVICE KIT, GASKETS, 660			
Part Number: AWT05-101189			
Diagram	Item	Qty.	Description
		1	MODEL 660, O-RING
		2	GASKET, SYN RUBBER-CIR CONN 12S
		4	GASKET, SYN RUBBER-CIR CONN 14S

Kit Name: KIT,FRONT HSG AND OVERLAY,660			
Part Number: AWT05-101190			
Diagram	Item	Qty.	Description
		1	ENCLOSURE, COVER-ZM660
		1	OVERLAY KEYPAD, AG, 660

Kit Name: KIT, JUMPER, ZM22X 660			
Part Number: AWT05-101335			
Diagram	Item	Qty.	Description
		4	SCREW, (M6X1 12MM LG) SST P/HD
		30	JUMPER, 2MM 2POS WITH GRIP

Kit Name: KIT, BACK HOUSING 4 WB, 660			
Part Number: AWT05-101191			
Diagram	Item	Qty.	Description
		1	GASKET, SYN RUBBER-CIR CONN 12S
		4	GASKET, SYN RUBBER-CIR CONN 14S
		1	ENCL, REAR, AG-4 WEIGH BAR
		1	WIRE HARNESS, AWT POWER, 660
		10	SCREW, PHIL PAN HD SS 4-40X.437
		4	SCREW, PHIL PAN HD SS 10-32X1/4
		10	NUT, HEX LOCKING SS 4-40UNJC-3B
		1	BRACKET, V MOUNT, 660
		1	COVER, DB9 PMT IP67
		2	SCREW, PHIL PAN HD SS 4-40X.312
		1	CABLE, USB-A WATER RES, 660
		1	WIRE HARNESS, AG AWT SCALE 660

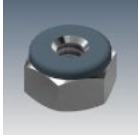
Kit Name: KIT, BACK HOUSING 1 WB, 660			
Part Number: AWT05-101192			
Diagram	Item	Qty.	Description
		2	GASKET, SYN RUBBER-CIR CONN 12S
		4	SCREW, PHIL PAN HD SS 4-40X.437
		4	SCREW, PHIL PAN HD SS 10-32X1/4
		4	NUT, HEX LOCKING SS 4-40UNJC-3B
		1	BRACKET, V MOUNT, 660
		1	COVER, DB9 PMT IP67
		2	SCREW, PHIL PAN HD SS 4-40X.312
		1	CABLE, USB-A WATER RES, 660
		1	ENCL, REAR, AG-2 WEIGH BAR
		1	WIRE HARNESS, PCBD/JB INT 660
		1	WIRE HARNESS, AMP POWER,660

Kit Name: SERVICE KIT, HARDWARE, 660			
Part Number: AWT05-101195			
Diagram	Item	Qty.	Description
		10	SCREW, PHIL PAN HD SS 4-40X.437
		4	SCREW, PHIL PAN HD SS 10-32X1/4
		10	NUT, HEX LOCKING SS 4-40UNJC-3B
		2	SCREW, PHIL PAN HD SS 4-40X.312
		9	SCREW, M3 X 6MM SELF TAP

11.3 System Block Diagram

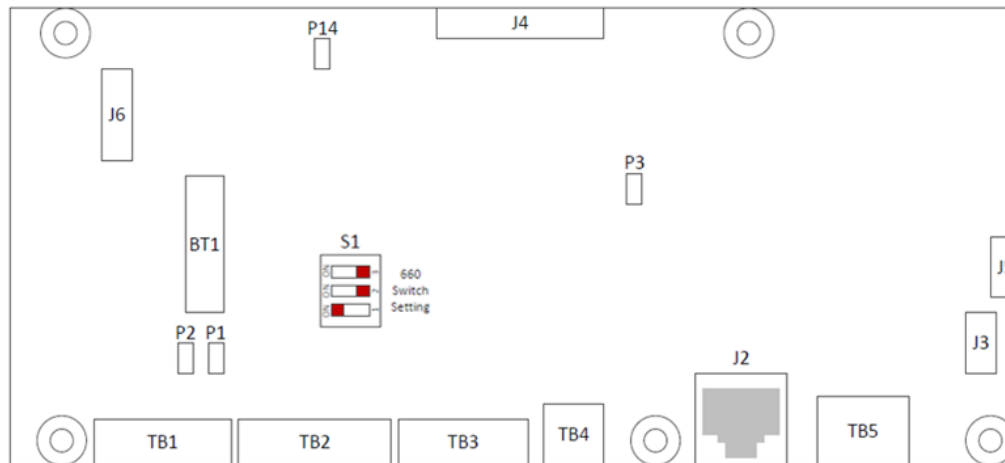

11.4 660 Jumper and Switch Settings

1. P3 is the On/Standby Key jumper. This has the same function as the 660 (bypasses the ON/OFF key and forces the board to turn on as soon as power is supplied to the board).
2. P14 is the Seal jumper. This has the same operation as the current Avery Weigh-Tronix indicators: it prevents metrologically significant software adjustments when the jumper is jumped.
3. S1 sets the indicator's Operating Mode. Ensure the switch positions match the 660 Switch Setting from the PCB Diagram image.

11.5 660 Remote Inputs and Outputs, Opto-22 Module

There are two IO (input or output) pins accessible through the DB9 connector. Follow the below steps to properly configure Remote Inputs and Outputs:



Note: Each IO pin contains an internal freewheeling diode connection back to the system's input supply voltage to protect the pin against overvoltage events such as those caused by switching inductive devices such as relays and motors. Due to this, the IO pins are tolerant of voltages up to the input supply voltage. Higher voltages may damage the IO circuitry.

11.5.1 Inputs

IO channels which are configured as inputs may be driven by either mechanical or digital input signals. Mechanical (remote switch) inputs receive their voltage from the identified indicator terminal. Digital logic inputs change state based on a secondary or remote interface (such as a PLC or HMI, human-machine interface).

Digital input signals should be at least 3.0VDC when high and below 0.5VDC when low for reliable operation. The pins would be tolerant of voltage up to the input supply voltage at maximum. Higher voltages may damage the IO circuitry.

- Identified the terminal numbers in the indicator (see DB9 Connector pinout below).
- DB9 High-Density Port

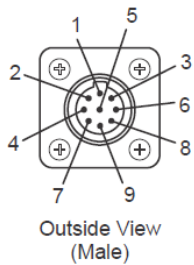

- Pin 1 = IO1 (In/Out)
- Pin 2 = COM1 RXD (In)
- Pin 3 = COM1 TXD (Out)
- Pin 4 = +VBAT @ 5A Max (Out)
- Pin 5 = Ground
- Pin 6 = IO2 (In/Out)
- Pin 7 = COM2 TXD (Out)
- Pin 8 = COM2 RXD (In)
- Pin 9 = +5V @ 500mA Max (Out)

11.5.2 Outputs

IO channels which are configured as outputs operate as open-drain transistor outputs which pull the pin to ground (GND) when activated.

There are a variety of interfaces for output control:

Relay: Electro-mechanical switching device capable of switching multiple voltages or currents

Opto Module: Solid state switching device capable of switching multiple voltages or currents

Transistor: Low voltage/low current switching device, typically not more than 5VDC or 100mA

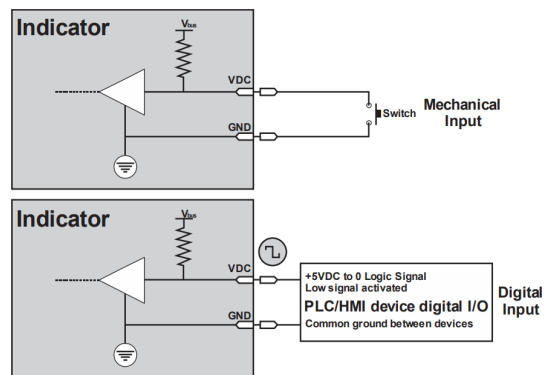

You must determine, from the customer, the voltage and current that will be switched. Be sure the indicator capabilities match the customer need. Below is an example of output wiring.



Note: LEDs connected directly to the IO pins ("transistor" output) may occasionally have a dull glow in the output OFF state due to a small reverse leakage current through the IO pin protection diodes. This is most pronounced in single diodes with a current limiting resistor powered from a 12V or 24V source. The effect may be reduced by using a string of LEDs with a forward voltage closer to the supply voltage, or by powering the LED from a smaller supply, such as the +5VDC supply.

660 Open-Drain Transistor Outputs

The outputs operate as open-drain transistor outputs which pull the pin to ground (GND) when activated. This allows them to be used as a low-side switch that can make or break a connection to ground for simple applications such as when driving an LED indicator or buzzer alarm. Caution must be used when driving external circuitry directly from the IO pins, as the transistor outputs have several limitations:

- The outputs can only operate as a low-side switch, making or breaking a connection between an external circuit and ground. They cannot be used to switch or supply a voltage to an external circuit.
- The outputs can only sink up to 250mA Max per IO pin.
- The maximum signal or supply which can be applied to an IO pin is the input supply voltage.

Reference the following sections for using the outputs to drive Relays or OPTO-22 Modules for applications which are outside the limitations of the transistor output operating modes.

Relays

Relays can be placed between the IO pins and the external circuitry being controlled to provide higher current or voltage handling, or to provide ground isolation between the indicator and the system being controlled. Refer to the image below for an example on using an indicator Output to drive a relay coil for controlling external circuitry.

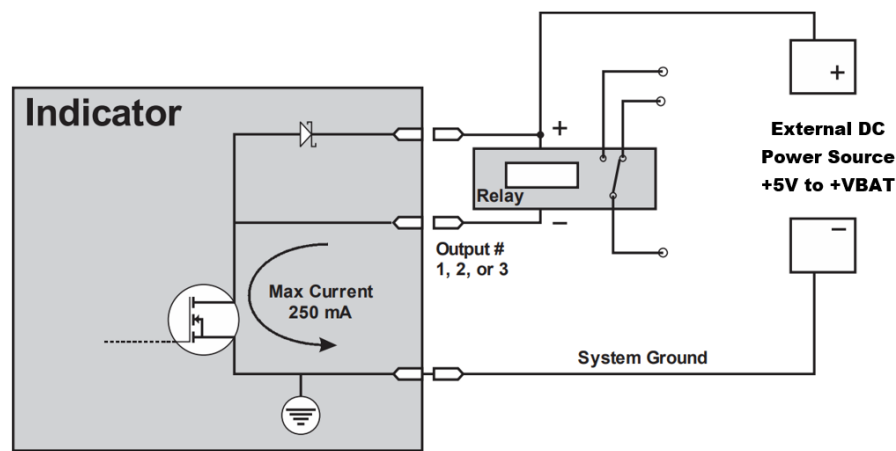

Opto Modules

Similar to relays, opto modules can be placed between the IO pins and the external circuitry being controlled to provide higher current or voltage handling, or to provide ground isolation between the indicator and the system being controlled. Opto modules are available in a variety of types. Make sure that the opto in the machine is compatible with the customer's voltage. There are AC optos, DC optos and optos with reed relay contacts. As well as optos of various voltage ratings, they may be polarity dependant.